



2019

Football Officials Manual
For a Crew of 4 Officials

4

www.taso.org

Football Officials Manual For A Crew of 4 Officials

Texas Association of Sports Officials



**Edited and Published by
Texas Association of Sports Officials
Football Division
1221 West Campbell Road, Suite 141
Richardson, TX 75080**

**(866) 283-TASO
www.taso.org**

Revised May 2019

Copyright © 2019 by Texas Association of Sports Officials, Inc.
All rights reserved. No part of this publication, including text, pictures or illustrations may be reproduced, stored in a retrieval system or transmitted in any form or by any means, electronic or mechanical, including photocopying, recording and storing or any retrieval system without permission from the Texas Association of Sports Officials Football Division.

PURPOSE OF MANUAL

The manual of football officiating is designed to make available to each and every TASO official, detailed information regarding the officiating techniques which, through evaluation and studied development, have come to be recognized as accepted standards of officiating performance.

This manual is an authoritative guide to the best in football officiating, hopeful that it will assist all officials in maintaining their effectiveness and making ready use of their potentialities.

This manual is designed to provide the best possible officiating techniques for TASO officials working Texas High School Football. TASO officials are expected to use the mechanics specified in this manual and are not authorized to deviate in any manner.

TABLE OF CONTENTS

SUMMARY OF APPROVED 2017 MANUAL CHANGES.....	iv
OFFICIATING REQUISITES.....	1
SECTION 1. GENERAL PRINCIPLES.....	2
SECTION 2. STANDARD UNIFORM.....	5
SECTION 3. OFFICIATING PROCEDURES.....	8
SECTION 4. PRE-GAME DUTIES ON FIELD.....	9
SECTION 5. TOSS.....	11
SECTION 6. GENERAL GAME DUTIES.....	13
SECTION 7. TIMING.....	17
SECTION 8. USE OF BEAN BAGS.....	22
SECTION 9. BALL HANDLING.....	23
SECTION 10. FREE KICKS.....	29
SECTION 11. PLAYS FROM SCRIMMAGE.....	33
SECTION 12. RUNNING PLAYS.....	35
SECTION 13. FORWARD PASSES.....	37
SECTION 14. GOAL LINE PLAYS.....	39
SECTION 15. FUMBLES.....	40
SECTION 16. SCRIMMAGE KICKS.....	41
SECTION 17. TRY AND FIELD GOAL PLAYS.....	44
SECTION 18. TIME OUTS.....	48
SECTION 19. MEASUREMENTS.....	50
SECTION 20. CALLING FOULS & ENFORCEMENT.....	51
SECTION 21. CLOSE OF A PERIOD.....	54
SECTION 22. ONE MINUTE INTERMISSIONS.....	55
SECTION 23. INTERMISSION BETWEEN HALVES.....	56
SECTION 24. EXTRA PERIODS.....	57
SECTION 25. POST-GAME DUTIES.....	58
SECTION 26. SIX-PLAYER FOOTBALL.....	60
SECTION 27. TASO OFFICIATING PHILOSOPHIES.....	73
PRE-GAME CONFERENCE.....	85
APPROVED SIGNALS.....	90

SUMMARY OF APPROVED 2019 MANUAL CHANGES

INCIDENT REPORTS: Targeting Fouls has been added to the list of incidents that require reporting. (25-2)

TARGETING: Targeting and language consistent with the UIL Exception has been added to TASO Philosophies. (27-Targeting)

OFFICIATING REQUISITES

COURAGE, A WORKING KNOWLEDGE OF THE RULES AND MECHANICS, HUSTLE, AND TACT are indispensable to a good official, but none any more important than – GOOD JUDGMENT!

RULES AND MECHANICS: An overall familiarity with the rules and full understanding of mechanics are necessary for the proper conduct of a game. The intent of each rule must be kept in mind. Each official should seek the happy medium between strict adherence and undue laxity. Situations arise in a game which cannot be foreseen and which cannot be covered in a rule book or manual. Football “sense” must supersede the most technical application of the rules.

COURAGE: A smooth running game suddenly can get out of hand as a result of an overly officious attitude toward players and coaches, or an undue laxity of enforcement. Conversations with a coach or a player should always be courteous without sacrificing dignity. If something is said or done which warrants a penalty, penalization should be done unobtrusively and without dramatization. A game is kept under control by proper administration of the rules, which can be best accomplished if no impression of militant supervision is created.

HUSTLE, BUT DON'T HURRY: Hurry should not be mistaken for hustle. There are times it is proper to speed the tempo of the game in order to get the ball back in play after an incomplete pass, to take a position on a foul situation, to prepare for a measurement, etc. Never hurry an injured man off the field. Never rush to get another ball before the play is over. Don't move the ball to the inbounds line without first checking for the need of a measurement. Don't pressure a captain's decision on a difficult option. Precision and care should be exercised in all situations. Hustle is essential. HURRY is a hazard.

TACT, BUT NOT SUBMISSION: Tact is necessary but should never be a justification for retreat from a position properly taken or a decision correctly rendered.

POISE, BUT NOT INDIFFERENCE: Staying loose is an asset in officiating, as in any other phase of a sport where fast reflexes are required. A relaxed appearance is a great help if it gives the impression of confidence. Care, however, should be taken to avoid the appearance of indifference. The poised official is able to remain inconspicuous as he moves to the right place at the right time.

SECTION 1. GENERAL PRINCIPLES

ARTICLE 1. KNOWLEDGE OF THE RULES:

Rule mastery will be perfected over time, and must be supplemented by ability to interpret rules and editorial changes correctly. These abilities are acquired through devotion of time and study.

ARTICLE 2. PHYSICAL CONDITION:

Football officiating is difficult and exhausting and requires 100 percent efficiency of mind and body. An annual physical examination should be a personal requisite to ensure your health, thus allowing you to assess your ability to officiate.

ARTICLE 3. MENTAL REACTIONS:

Decisions must be instantaneous and rulings announced without delay. To ensure improved instinctive reaction to play situations, continue to review the different combinations of circumstances that may occur.

ARTICLE 4. DUTIES AND RESPONSIBILITIES:

Each official must have a thorough knowledge of the duties of his own position and must also be fully informed concerning the duties of each of the other officials. He/she should be prepared to assume any one of the other positions whenever circumstances require rearrangement of assignments.

AN OFFICIAL MUST:

- A. Know the down and yardage prior to each snap.
- B. Be ready to assist any official that is temporarily out of position.
- C. Observe erroneous procedure or rulings of other officials and attempt prevention and correction whenever possible. Under no circumstances should an argument develop on the field between officials.
- D. Know the prescribed signals and when and how they should be used.
- E. Secure a new ball if appropriate, after all action has ceased and be able to handle and pass the ball properly.
- F. Be alert to happenings away from the ball when play has left his immediate area.
- G. Call time-out for any player who is obviously injured or disabled. Never hurry the treatment of an injured player. Recognition of injured players is the concern of all game officials. Clock can be started if time-out is not necessary.

ARTICLE 5. SIGNALS:

All signals should be given promptly, distinctly and conspicuously as they are the non-verbal communications tools we use to inform. The preliminary signal on fouls and the regular signal after enforcement (or declination) of a penalty shall be given by the Referee only. (See Code of Signals).

ARTICLE 6. ENFORCEMENT:

All rules should be strictly and fairly enforced. There shall be no deviation from the NCAA Football Rules with UIL exceptions.

ARTICLE 7. HUSTLE:

Keep the game moving smoothly from start to finish. Do not permit haste to interfere with duties or correct determinations.

ARTICLE 8. BOXING IN:

Smart officiating requires keeping the players "boxed in" and avoidance of officials being "boxed in". "Outside looking in" is essential for sideline and end line coverage. The ultimate goal is to have each play viewed from more than one direction.

ARTICLE 9. OFF BALL OFFICIATING:

Officials should not be ball watchers. The official nearest the action should take the primary responsibility for the ball, but should also be alert to action around the ball. The official that is the farthest distance away should take the widest, "big picture" view of the action, looking for unsportsmanlike acts and threats to player safety. The officials in between should work in "rings". The closer you are to the ball, the smaller your "ring" is.

ARTICLE 10. COOPERATION:

Team work is essential among officials. If a ruling is puzzling, relay explanation to press box. Never issue direct or indirect newspaper interviews, statements or stories concerning games in which you are an official. Continuous verbal and non-verbal communication between all officials during the game is essential for effective game administration.

ARTICLE 11. DON'T DISCUSS:

Do not discuss with a coach the play or players of his opponents in a game which you will officiate or are officiating. Coaches and other school representatives are expected to submit reports on work of officials to the governing authority and not to make evaluations through conversation with other officials or through public statements.

ARTICLE 12. OFFICIALS' "ABCs"

- A - Ability to handle players in firm, fair, and friendly fashion.
- B - Knowledge, understanding and correct application of the rules.
- C - Knowledge of an adherence to approved mechanics.

ARTICLE 13. WHEN IN QUESTION RULES:

- A. Block below the waist (2-3-2-a).
- B. Block in the back is below the waist (2-3-4-a).
- C. Catch or recovery not completed (2-4-3-h).
- D. Ball not touched on kick or forward pass (2-11-4-d).
- E. Ball is accidentally kicked (touched) (2-16-1-d).
- F. Forward rather than backward pass if thrown from in or behind the neutral zone (2-19-2-a).
- G. Forward pass and not fumble (2-19-2-c).
- H. It is a catchable forward pass (2-19-4 and 7-3-8-c).
- I. Stop clock for injured player (3-3-5-a-1).
- J. Forward progress stopped (4-1-3-a).
- K. Kick catch interference (6-4-1-b and e).
- L. Touchback rather than safety (8-5-1-a).
- M. Is targeting with the crown of the helmet (9-1-3).
- N. Is initiating contact to the head or neck area of a defenseless player (9-1-4).
- O. Twisting, turning, pulling facemask or helmet opening (9-1-8-b)
- P. Roughing kicker rather than running into (9-1-16-a-8).

ARTICLE 14. ALTERNATE OFFICIAL-

For some games, an Alternate Official may be assigned in case another official is injured during a game. The Alternate Official will be considered a part of the crew, should travel and arrive at the game site with the crew, and participate in pregame activities with the crew. The Alternate Official will dress in the same uniform as the game crew and will wear a black shirt or jacket at all times when on the field. During the game, the Alternate official will be positioned off the **H** sideline, moving up and down the field as play dictates, paying close attention to each play in preparation for the possibility of entering the game. The Alternate Official will only enter the game in situations where another official is injured and cannot continue his duties.

SECTION 2. STANDARD UNIFORM

ARTICLE 1. TRADITIONAL UNIFORM:

It is essential that all TASO football officials dress in a consistent manner. All members of a crew must be similarly dressed. For all varsity games the uniform worn by all officials shall include the following:

- A. **SHIRT** - Standard black and white knit, long tail, 2¼ inch vertically striped officials' long and short sleeve shirts with pocket on the left breast (without emblem or numbers, other than small manufacturer's logo) and complete with knit black "Byron" collar and black cuffs. Mesh shirts may be worn if entire crew is so garbed.
- B. **PANTS** - The Pants shall be full length black pants. The pants must include a one and one-quarter inch white strip on the seam of the leg, must not be cuffed, and must continue to the shoe without a break.
- C. **SOCKS** – When wearing approved pants, officials will wear black socks
- D. **SHOES AND BELT** – Predominantly black shoes with black laces and appropriate soles or cleats. A black belt, a minimum of one and one-quarter inches and a maximum of two inches in width shall be worn.
- E. **CAP** - Brooklyn style solid black cap with traditional narrow white piping (without emblem or numbers, other than small manufacturer's logo) shall be worn by all but the Referee, who shall wear a Brooklyn style solid all-white cap (without emblem or numbers, other than small manufacturer's logo). The cap shall be oriented with the bill facing forward and squarely covering the forehead of the official. For state championship games only, the logo of a sanctioning body may appear on the front two panels.
- F. **FOUL MARKER** - All officials shall be equipped with a light gold foul marker, 15" X 15" and weighted in the center with pebbles, sand or beans and worn *INCONSPICUOUSLY*.
- G. **BEAN BAGS** - All officials will be equipped with one or more **white or black** bean bags for marking spots. Bags shall be filled with pebbles, sand or beans. The entire crew must use the same color of bean bag.
- H. **JACKETS** – Jackets are not considered part of the official uniform.
- I. **UNDERSHIRTS** - All undershirts which show should be black. Long sleeved undershirts shall only be worn with long sleeve standard official's shirt.
- J. **GLOVES** - Gloves when worn shall be black.
- K. **NUMBERS, LETTERS, AND EMBLEMS** – A 2" x 3³/₈" American Flag will be worn on the left sleeve and a 2" x 3³/₈" Texas Flag will be worn on the right sleeve. A standard TASO patch as prescribed by the TASO Football Board of Directors shall be worn above the left breast pocket.

The crew may opt to wear letters or plackets for Varsity games only. The plackets must be worn by the entire crew and must be securely affixed to the back of the shirt, centered 3" below the collar. The letters shall align with the TASO mechanics manual, i.e. R, U, H, L, B, S and F.

All other numbers, letters, and emblems visible on uniform or equipment are prohibited, except as may be specifically directed by the TASO Football Board of Directors or the TASO Executive Director. Requests for memorial or other special insignia or emblems must be submitted to the Executive Director for approval.

- L. **HELMETS** – A protective helmet may be worn by the Umpire. When worn, helmets will be black, without a bill and must be fitted and secured with a black chin strap which must be secured when the ball is in play.
- M. **MICROPHONES** - Microphones for officials other than the **R** are prohibited. Protected wireless communication systems open only to the crew and observers may be allowed if approved by TASO prior to use on the field.

Below are the standards, along with a brief explanation, that all crew systems must meet in order to be considered for approval. A list of approved systems is available in the Member's Portal at taso.org and available for crew use without prior approval. While other radio systems may meet the standards below, if they are not on the approved list they may not be used without written approval from TASO.

- **Private transmission.** Radios must provide a system of "privacy codes" which allow for private communication and conversation within the system while also reducing interference.
- **Push to talk operation only.** Allows more focus by officials without the distraction of open microphones.
- **Paired with headset and microphone.**
- **Water resistant.**
- **Black or black & white are the only acceptable colors.**

ARTICLE 2. TASO-FOOTBALL APPROVAL:

All uniforms meeting the above specifications are approved by the TASO-Football Division board of directors.

ARTICLE 3. UNIFORM CHECK:

Check your uniform and equipment before leaving home and again check each other's uniform prior to the game. Test whistle, watch (carry spares) have game data cards, foul marker, bean bag(s), a down indicating device and pencils. Have shoes polished and entire uniform neat and clean.

ARTICLE 4. SUMMER UNIFORM:

A "summer uniform" is approved for wearing in scrimmages and sub-varsity, in accordance with Chapter policy, but all in the crew must wear the same uniform. A "summer uniform" is a traditional uniform with black shorts with a 1 ¼ inch white stripe down the side. Black socks will be worn with the black shorts.

SECTION 3. OFFICIATING PROCEDURES

ARTICLE 1. BEFORE ENTERING FIELD

- ALL** A. Attendance at the pre-game conference at least 1 ½ hour before game is mandatory for varsity games. Only an emergency and notice to the Referee may excuse absence.
- H** B. In the absence of the **R**, you are responsible to ensure that a pre-game conference is conducted in accordance with the pre-game conference guide in this manual.
- U** C. If not provided, arrange dependable transportation to and from the stadium.
- L** D. Make certain you have correct time. Other officials will check their watches with yours. Confirm starting time with home management and arrange for punctual arrival of officials on field.
- E. Playing time shall be kept with a game clock which may be either a stop watch, operated by the **L** or a field clock, operated under the direction of the **L**.
- F. If delivered to the dressing room, take over game balls from **R**. Take to field just before game time. Have stopwatch or watches ready if necessary.
- R** G. Ensure that you have an accurate timing device for timing the 25 second count.
- H. Conduct a thorough meeting using a pre-game conference guide. The purpose of a pre-game conference is to prepare the crew mentally. It is important to solidify the thinking of officials in regard to procedures, rules and interpretations and enforcement. Referees will vary their approach to a pre-game conference, but the value of organizing and unifying the techniques to be employed in a game cannot be overemphasized. No unauthorized visitors shall be allowed in this important session.
- L** I. Instruct clock operator. (See Section 7)
- R, U** J. Visit each dressing team one hour and fifteen minutes before kickoff. **U** inspects player equipment, braces, bandages, tape, etc. **U** should record numbers of players with illegal equipment and recheck when players come onto the field. **R** checks official time and confirms starting time with each head coach or designated representative. Remind head coach of equipment rule requirements and his certification that all players are equipped according to rule, and review any unusual game situations, extensions of half-time, etc. Additionally, the **R** may ask each Coach for insights on: scrimmage play formations, free kick formations, return formations, etc. *Note: If coaches or teams are unavailable at 1:15:00, conduct above conference a minimum of 45 minutes prior to kickoff.*
- ALL** K. Leave the stadium dressing room together at least 20 minutes before game time.

SECTION 4. PRE-GAME DUTIES ON FIELD

- A. Anytime players of both teams are on the field, beginning 30 minutes prior to the scheduled game time, at least one official shall be present on the field.
- ALL** B. Arrive on the field as a unit, no later than 15 minutes before game time and sooner if duties require. Go to bench on press box side and then disperse for pre-game duties.
- C. Note location of press box, team areas and benches. Check identities of team doctors and trainers.
- R, L** D. Inspect entire field. Observe any unusual markings or serious irregularities and advise other officials. Take measures to remedy or remove any hazardous obstructions within or near boundary lines, requesting assistance from management and from other officials as necessary.
- U** E. Spot check player equipment, bandages, tapes, etc. Have trainer make any needed corrections.
- R, U** F. Arrange with captain of the team whose bench is on your sideline to meet you in the dressing room or at the 50 yard line, on his sideline, 4 minutes before game time.
- H, L** G. Organize your assistants, locate yardage chain and down marker and have assistants ready with all equipment on the sideline opposite the press box. An auxiliary box and line to gain indicator(s) may be used on the press box side. The auxiliary box and line to gain indicator(s), if used, will be under supervision of the **L**. Remain on the same side throughout the game. Check the chain for kinks, knots and weak spots. Check chain against 10-yard measure on the field. Check chain for tape marker at mid-point.
- H** H. Instruct your assistants to:
1. Set down marker, rods and clip where indicated by you. Position ground markers adjacent to sideline. Box man places down marker on sideline where indicated. Chains are then set on sideline and clip attached on side of yard line closest to rear chain rod. When chains are set, box man retreats six feet and establishes spot where chains are to be reset after clip has been attached. On touchback situations set front stake on the 30 yard line and stretch chain back toward the 20 yard line. Emphasize that your assistants should move only at your direction and to step lively when a move is indicated.
N O T E : Be prepared to give complete and through instructions to assistants if a different line to gain device is to be used in the game .
 2. See that the chain is taut and un-kinked at all times.
 3. Make no remarks to players nor express opinions concerning any ruling.

4. Never move down markers, chains or change the number of the down unless so directed by the Linesman. The **H** will check with the Referee.
 5. Remove themselves and all equipment outside the limit line for free kicks.
 6. Chains are to be laid down and only the down marker is used when there is a first down inside the 10-yard line.
 7. Remain neutral and follow instructions at all times.
 8. You are responsible for the conduct and performance of the assistants.
- L** I. Instruct auxiliary box operator concerning duties and use of line-to-gain indicator. Ensure that the auxiliary box is worked approximately six feet off the sideline. Auxiliary box operator is not to move until ball is ready for play on succeeding down.
- L** J. Be sure the game balls are available and instruct ball retrievers on game duties. Ball persons shall not enter the field unless requested by the officials.
- ALL** K. After completing pre-game duties, retire to benches. **R**, and **H** to **H**'s side, **U** and **L** to press box side.
- R, U** L. Bring the captain(s) to the 50 yard line on the sideline at their team area four minutes before game time. Introduce yourself to captain(s) on your sideline.
- H, L** M. Responsible to have the team on your side of the field on the field prior to game time.

SECTION 5. TOSS

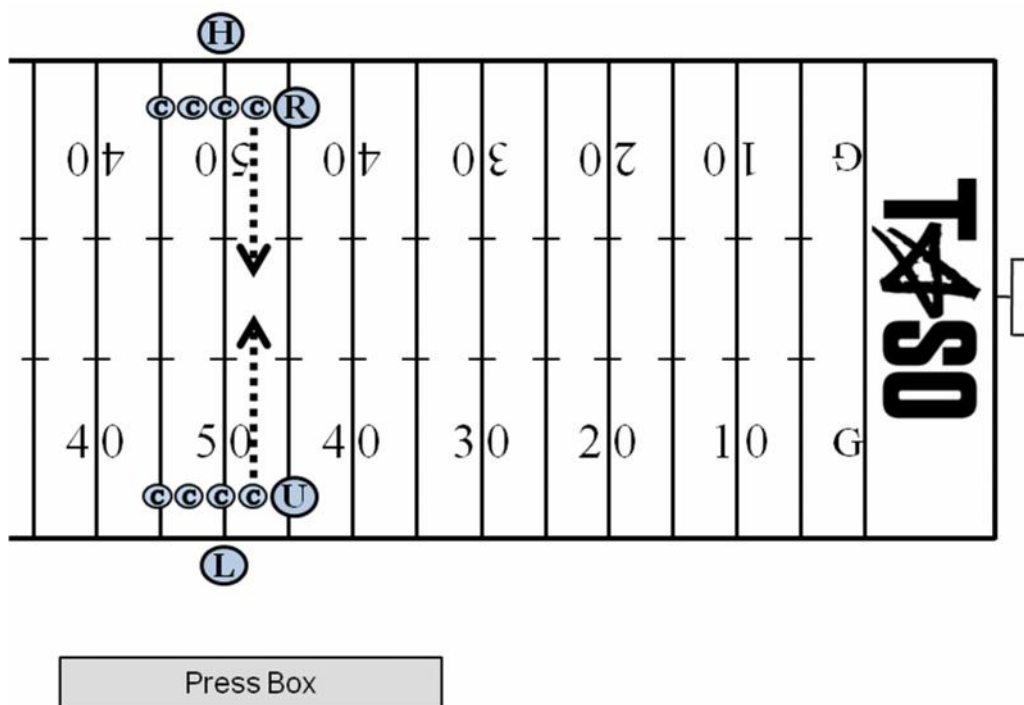

R and U in 'mirror' positions on ends of captains, to meet together with captains at mid-field. U moves to opposite end of captains after introducing his captains to R.

ARTICLE 1. PROCEDURES

- R, U** A. R and U will escort their Captains to the center of the field.
- H, L** B. After captain(s) are escorted to the center of the field, take a position at the 9-yard marks. DO NOT ALLOW TEAM MEMBERS WHO ARE NOT INVOLVED IN THE TOSS INSIDE THE 9- YARD MARKS ON YOUR SIDE. If team members do not approach the 9-yard marks, return to the team area. Stay between the team and the 9-yard marks.
- C. Have the game ball from the team on your side until the winner of the toss is determined.
- U** D. Introduce your captain(s) to R, and remain with the R to witness toss and verify choices.
- R** E. COIN TOSS:
1. Introduce captains to each other.
 2. Advise captains of any irregularities in timing or special ground rules.
 3. Have captains face each other with their backs to the sidelines. Ask visiting captain to call the toss. Ask the home captain to repeat what the visiting

captain called. If either captain, or **R** or **U** disagree, seek clarification BEFORE making the toss. **R** shall allow the coin to hit the ground. If warranted by field conditions, **R** may catch the toss.

4. Indicate winning captain by placing your hand on his shoulder. Explain and obtain his option. Explain loser's options and obtain his choice. Should a captain who wins the toss waive his choice until the second half, the Referee will:
 - a. Indicate the winner of the toss by placing his hand on that captain's shoulder;
 - b. Step clear of captains, turn to the press box and signal "choice declined"(S 10);
 - c. And, subsequently request first choice from the opposing captain.
 - d. Present remaining options to the other captain.

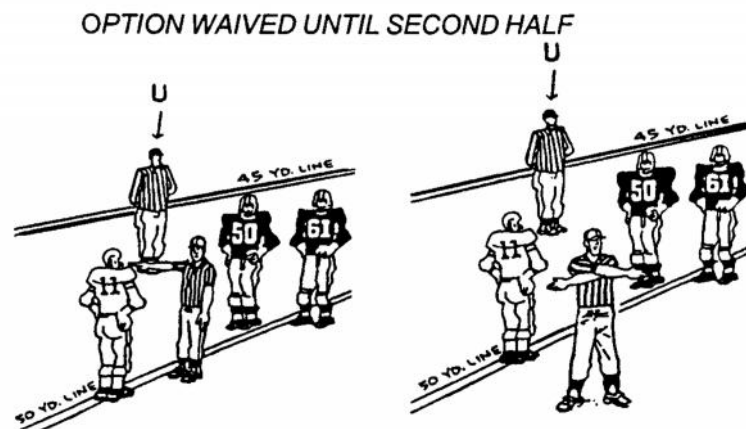

*When captain elects second half option, **R** should step clear of captains (a minimum of three steps) and clearly indicate with signal #10 that captain has deferred his choice to the second half. Following this signal the **R** will give other captain the option and continue usual coin toss procedure.*

5. Face press box, place captains in position facing each other with backs to the goal which they will defend.
6. Signal choice of choosing captain by swinging leg simulating a kick or make a catching motion while facing the same direction as the winning captain. If choosing captain elects to defend a goal, point with both arms extended toward the goal line and then give an appropriate signal for the choice of the other captain.
7. Start the game at scheduled time.

ARTICLE 2. TOSS COMPLETED

- ALL** A. When toss is completed, other officials will join the **R** and **U** at mid field and make a written record of the toss results. Move to kickoff positions simultaneously.
- H, L** B. When moving to your kickoff position, go directly to your sideline and move teams and coaches back to clear the sideline before going to your kickoff position.

SECTION 6. GENERAL GAME DUTIES

ARTICLE 1. SUBSTITUTIONS AND COUNTING PLAYERS

- ALL** A. All officials are responsible for legality of substitutions. The **U** and **R** are responsible for the correct number of players on the offensive team. **H** and **L** have responsibility for the correct number of players on the defensive team.
- U, L** B. On free kicks, **U** & **H** are responsible for the number of players on the kicking team. **R** & **L** count the players on the receiving team.
- ALL** C. Use the fist signal when the team you are counting has 11 players on the field. The open palm signal will be used when the team you are counting has fewer than 11 players on the field.
- D. In situations where Team A is either in a no huddle formation or has already broken the huddle and substitute(s) enter the field:
1. **R** and either **H** or **L** (the official working Team A's sideline) should signal, by arms held with closed fists extended horizontal to the ground, that Team A is substituting and Team B is allowed the opportunity to do so as well.
 2. If it is apparent that Team B will respond with substitutes **R** will then signal in the same manner, indicating to the **U** that action is required.
 2. **U** should move to a position over the ball when seeing either this situation or signal.
 3. Upon completion of the substitution process by both teams, **R** will release **U** to his normal position by dropping his arms and pointing at **U**.

ARTICLE 2. WRITTEN RECORDS AND OTHER GENERAL GAME DUTIES

- ALL** A. Make written record of charged time-outs and fouls you call. The position of ball at end of first and third periods, including down and distance, is the responsibility of the **R**, **H** and **U**. **L** is responsible for recording elapsed time and making certain the status of the clock is correct.
- B. Convey any message you have for other officials promptly. Avoid any position which suggests a huddle of officials, unless necessary.
- C. Be alert for players being out of bounds before a snap or free kick.
- D. Watch for fouls, being certain to know:
1. Spot where run or scrimmage kick ended.
 2. Spot of foul, position or number of offending player.
 3. Whether, ball was loose, in possession or dead when the foul occurred.
 4. That clock is stopped.
- E. Be ready for any type of play or unusual development. Always be prepared to rule on muffs, fumbles backward and illegal forward passes and know which

team possessed a fumble or backward pass before it went out of bounds between goal lines. On recovered fumbles, nearest official must rule on possession by prompt signal. If possible, point to recovering player to assist press box.

- F. Be alert to rule on dead ball behind a goal line. Indicate ruling by prompt signal.
- G. Signal time-out (S3) when the rules provide for stopping the clock or when time-out is charged to a team or to the **R**. Repeat time-out signal of other officials.
- H. Covering officials will use the dead ball signal (S7) when the play ends and there is no other reason to stop the clock.
- I. A winding signal (S2) may be used when the ball becomes dead close to the sideline and the covering official rules that the ball remained inbounds. When the covering official uses a winding signal, make only two complete rotations of the arm. If an obvious first down has been made by Team A, the clock shall then be stopped.
- J. Indicate by touchdown signal (S5) (without reference to any official) when the ball is legally in possession of a player on or behind his opponent's goal line. **R** check for any foul which might affect the ruling, if none, then give touchdown signal.
- K. Check for false starts and feints.
- L. Leave no doubt in the minds of players or other officials, as to any ruling you make.
- M. Be especially alert for acts of misconduct. (Rule 9)
- N. Before the ball is put in play, adjust position as necessary to ensure you can clearly see your key and area of responsibility. There can be no excuse for failing to be in a good officiating position before the ball is put in play.

ARTICLE 3. AFTER EACH SCRIMMAGE DOWN

- R**
 - A. After each scrimmage down, the **R** should go quickly to the appropriate position where he can observe the offensive huddle. He should then check the down and distance with the H and announce and indicate the new down. If play clock is to be started on the **R**'s signal, **R** should then declare the ball ready for play, by sounding his whistle and giving ready signal (or wind the clock). **R** should only go to the line of scrimmage for non-routine events, close measurement, etc. Under unusual circumstances this procedure may vary and require discretionary action by **R**.
 - B. If by rule the clock should be started after Team A is awarded a first down, **R** will declare the ball ready for play by starting the clock and sounding a soft whistle when the point of the new series of downs has been established by H and other officials are ready to resume play.

- C. If by rule the clock should be started following a penalty, **R** will declare the ball ready for play by starting the clock when certain the players and officials are ready to resume play.
- D. When the offensive team is attempting to run a hurry-up play, **U**, after the ball is spotted by **U**, will inform both teams simultaneously, that the ball may not be snapped until the whistle is sounded OR the **U** advises the offense that play can begin. **U** will stand over the ball until **R** has backed away from the neutral zone and then indicates the **U** to back out of the way. As soon as **U** is clear of the neutral zone and in position to officiate, **R** will declare the ball ready for play (or wind the clock) and simultaneously sound his whistle OR the **U** will advise the offense play can resume.
- R**
- E. Upon assuming position for the next down:
1. Recheck number of downs with other officials, showing numbers of fingers, closed fist indicates fourth down.
 2. Assume the position where you can see the ball and the offensive tackle on your side of the ball at the snap.
 3. Checking legality of backfield formation and one second stop following shift or huddle.
 4. Know which backs are eligible to touch a forward pass. On spread formations you are responsible for backfield group directly behind the ball as to illegal motion and eligibility.
 5. Check blocking behind the line after the snap. Be alert for pass thrown toward you. Do not pursue the ball too closely. You are responsible for the ball and runner behind the line of scrimmage. When the runner crosses the line of scrimmage, he will be the responsibility of the flank officials. Be alert to the play behind the ball.
 6. Unless in position to determine that ball is legally in possession on or behind opponent's goal line, check for fouls by other officials before giving touchdown signal, signal time-out and proceed as usual.
 7. Responsible for official score.
- U**
- F. If **R** omits ready signal, remind him immediately. Observe ineligible on the scrimmage line. Determine in pre-game conference sharing this responsibility with **H** and **L**. You are primarily responsible for detecting any illegal advance on forward passes.
- G. Assume primary responsibility for determining the legality of defensive signals.
- H . Take position to observe ball at snap.
- I. Be alert for legality of player equipment.
- J. **U** is primarily responsible for lateral placement of the ball at the previous spot after an incomplete pass, penalty, etc.
- H**
- K. Check down marker for correct number and indicate placement to assistant. Be sure there are no fouls or other reasons for holding spot of previous down before signaling the assistant.

- L. Signal number of each down by holding one arm aloft with correct number indicated by extending fingers. Closed fist indicates fourth down.
 - M. Anticipate any call for measurement and be on sideline ready to bring chain when signaled by **R**.
 - N. Each time a new line to gain is established, personally mark the spot on the sideline where the down indicator is to be set and be sure that it is set correctly and then moved off sideline.
 - O. When a first down is awarded inside the 10-yard line, only the down indicator will be used. The chain crew will ensure the down indicator is returned to the proper spot if forced to move.
- H, L**
- P. Be alert for all possible pass receivers. Observe eligible receivers on your end of the scrimmage line. Each is responsible for players who spread to his side of the field. Be certain that all players are boxed in at the snap and that all offensive players have complied with the 9-yard mark restrictions.
 - Q. Stay wide as you mark progress with downfield out thrust foot (unobtrusively, not making a production out of it). Do not jump over players. If necessary, come into the field as far as you can. Hold spot with foot until you are sure **U** or other official has spot.
 - R. Be aware of the importance of assisting **R** in marking forward progress behind the neutral zone, particularly when goal line is involved.
 - S. Check for encroachment, offside and other scrimmage infractions. Assist **U** on legality of numbers of interior offensive linemen on split or wide formations.
 - T. Check for backs or linemen illegally in motion. Check backs on your side of the snapper for illegal motion and flankers on your side for one second stop after the huddle.
 - U. Be alert for illegal blocks by players spread to your side more than 7-yards from the offensive middle linemen and by backs outside the normal tackle position.
 - V. Be certain that the entire offensive team observes the one second shift requirement.
- L**
- W. Be alert for all pass receivers. Give attention to play on tight end or ends moving off the line of scrimmage and to continuing action downfield as well as play near the sidelines and out of bounds. Be aware of offensive players having complied with the 9-yard mark restrictions.
- R, U**
- X. **R** or **U** shall determine the legality of each ball before it is put in play for each down.
- ALL**
- Y. Before free kick or snap which starts any period, complete all prescribed duties.

SECTION 7. TIMING

ARTICLE 1. GAME TIMING

- L** A. General
1. All game timing except the 25-second interval is under the direction of the **L**. He is primarily responsible for recording elapsed time and making certain the status of the game clock is correct.
 2. All time intervals, team time-outs, between periods and half time are the responsibility of the **L**, unless specific governing authority policy requires a different game official assume the responsibility for a media (radio/TV) time-out.
- B. Pre-Game**
1. Make certain you have correct time. Other officials will check their watches with yours. Confirm starting time with home management and arrange for punctual arrival of officials on field. Have stop watch (or watches) ready if necessary.
 2. Playing time shall be kept with a game clock which may be either a stop watch operated by the **L** or a field clock operated under the direction of the **L**.
 3. When a clock operator is assigned and a field clock is official, be certain that clock equipment is in good condition. Arrange for relaying information and for signaling the operator, especially regarding 10-second runoffs.
- R, L** 4. The game and 25 second clock operators will report to the **R/L** prior to the game. They will be instructed:
- a. Clock operators shall report to the official's dressing room at the stadium 60 minutes before game time to synchronize timer's watch with official game time as established by the **L**.
 - b. To advise officials as to the location of the clock operator in the press box or on the sideline, and to determine procedure for communications with time and check this procedure preceding game.
 - c. To discuss coordination of starting and stopping the clock in accordance with the playing rules and for relevant signals related to the 10-second runoff.
- R** d. The field clock is to start 30 minutes before game time and will run during the 20 (28 in UIL) minutes of half-time intermission. The 20 (28 in UIL) minutes of half-time will start when the players and coaches leave the field. **R** will give the "start the clock" signal from the end zone. All pre-game and half-time activities will be synchronized with the official game clock.
- L** e. The clock operators shall each have an extra stop watch available in case of pick up the correct game time on his stop watch.
- f. Should the field clock become inoperative, the public address announcer will indicate to the crowd that the field clock will not be official until the malfunction is corrected and subsequent announcement made over the P.A. system. The **L** will alert the P.A. announcer concerning remaining time as often as possible.
- C. Game Procedures for Officials and Timers**
- TIMER** 1. On all free kicks, start the clock when the ball is legally touched in the field of play, unless the ball is caught or recovered by a player who is legally down. In this case, the clock will not start. The nearest official(s) will signal the legal touching of the ball by indicating that the clock should start. The clock will start

when the ball crosses the goal line after being first touched by the receivers in the end zone. Usually, this will occur when a receiver carries the ball out of the end zone. It could occur on a muff or fumble, however. In any case, the **R** or **L** will be indicating that the clock should start.

2. Under NCAA football playing rules the official who declares the ball dead will be the first official to signal a time-out when the team in possession of the ball meets the requirements for first down. Key yourself on him as the clock will usually stop on long gainers.
3. Any official may signal a team time-out, so be alert to stop the clock.
4. The clock is not to be stopped on plays near a boundary line unless an official so signals. Many times the ball goes out of bounds after having been declared dead in the field of play and no time-out legally occurs. If a pass is touched or caught out of bounds, the incompleteness signal will stop the clock. *Note: On some plays near the sideline and in advance of the line to gain, an official may give a winding signal to indicate the ball is inbound and follow it by a stop the clock signal for an apparent first down. Be alert for both signals.*
5. Game officials and clock operators are to be sure that a time-out is indicated and the clock is stopped under the following circumstances:
 - a. Whenever a team or an official's time-out is charged.
 - b. After any score.
 - c. When a live ball goes out of bounds.
 - d. On a penalty.
 - e. When either team is awarded a first down.
 - f. Following an incomplete pass.
6. After the clock has been stopped, it will be started again on the **R**'s (wearing the white cap) "Start the Clock" signal, or if no such signal is given, the game clock will be started on the snap, or legal touching of a free kick. (See #1)
7. In case of a pile-up anywhere on the field, be alert, an official may stop the clock until the congestion is over. The **R** then may start the clock again before the ready for play signal.
8. The game clock should not be stopped if the 25-second clock is started in error.
- L** 9. When time for half expires, start the field clock on **R**'s signal when field is cleared of players and officials.
10. The **L** shall always be aware of the condition of the clock and the time remaining in any period. In the event the clock is running when it should be stopped, the **L** shall make and repeat the appropriate signal until the clock has been corrected (only **R** shall start the clock on the ready for play). If appreciable error is noted, or if inefficiency is habitual, the **L** shall call time-out and so advise the **R**. Officials will review these procedures with the timer before the game.
- L, U** 11. The **L** and **U** will keep the **R** informed of the time remaining in each period. Either official or the **R** will sound the whistle if time expires before the snap or advise the **R** at the end of the down if time expired while the ball was in play.
- R** 12. When the period ends, the **R** will so indicate by holding a ball overhead with one hand and arm extended. Following this signal, a horn or siren may be sounded.
13. Timing errors on the game clock, or by an official may be corrected by the **R**. Exact information as to the timing error must be available from either the clock operator or game officials. These timing errors may only be corrected in the period in which they occur.

ARTICLE 2. CLOCK OPERATION

- A. Clock Operators
 1. The clock operator is an integral member of the officiating crew and game administration. Unfair advantages accrue when the game clock is not started or stopped promptly. Great care must be exercised to see that no time lag occurs in starting or stopping the clock.
- L**
 2. The governing authority or assigning agency is to be notified immediately following the game (by the **L**) if there is any breakdown in cooperation between game officials and the clock operator during the game, or if any malfunction of the game clock occurs. Timers are encouraged to report crews that are not cooperative or whose signals are not clear and accurate.
- B. Charged Team Time-Out
 1. Time each time-out interval. When 20-seconds remain before the ready-for play signal is to be given (or when both teams indicate readiness to resume before that time), notify the **R**.
- C. Intermission Between Periods
 1. Time one-minute interval between quarters. When 20-seconds remain before the ready-for play signal is to be given, notify the **R**. If a media time-out is being utilized, governing authority policy may assign a different official to this duty.
- TIMER**
 - D. Intermission Between Halves
 1. When time for the half expires, start your stopwatch on **R**'s signal when field is cleared of players and officials.
 2. Keep official informed as to running time. Make sure crew arrives at field to start second half on time (at least 3 minutes before kickoff).

ARTICLE 3. PLAY (25/40-SECOND) CLOCK**A. General**

1. All timing involving the play count is under the direct supervision of the **R**.
2. When play field clocks are available, they are the official delay of game time piece. The assigned play clock operator will work under the supervision of the **R**.

B. Pre-Game: The play clock operator should report to the **R** 60 minutes prior to the game. If the play clock operator does not visit the dressing room, it is advisable to attempt to discuss timing procedures with the individual.

He will be instructed:

1. To set the displays prior to plays.
2. To start the clocks on the **R**'s ready for play signal or an official's dead ball signal (see chart at end of this Article.)
3. To leave the displays at 00 seconds if there is a delay of game penalty.
4. To reset the displays immediately to 40 seconds when the ball is put in play if there is no delay foul.
5. To reset the displays to 25 seconds anytime the **R** interrupts the play count.
6. That if there is a malfunction, both clocks will be turned off until the problem is corrected. Both coaches will be notified if the field play clock is no longer official. The play count will then be restarted at plays with the **R** manually timing the count on his watch.
7. That with less than 40 seconds (or 25 seconds if the play clock is starting on the Referee's signal) remaining in any period and the game clock running, the play clock shall not run.

NOTE: If the play clock is erroneously started, it shall be stopped immediately.

C. Duties Before Each Play

- R**
1. Observe the start of the play clock with the **R**'s ready signal or an official's dead ball signal.
 2. Check time consumed in snapping and free kicking the ball and call play clock infractions. Stadium clock located at each end of the field operated under the supervision of **L** will officially time the play clock. In obvious field goal and scrimmage kick situations or when there is no field play clock, the **R** may assume responsibility for the count.
- R**
3. If visual clocks become inoperative, raise one arm straight overhead during the last 10- seconds. Drop that arm and extend it out to the side, fist closed, during the last 5-seconds

PLAY (25/40-SECOND) CLOCK CHART

BASIC PREMISE: The play clock will **ALWAYS** start at 40 seconds unless there is an *administrative* stoppage.

REFER TO THE FOLLOWING TABLE FOR SITUATIONS WHEN THE PLAY CLOCK WILL BE SET AT 25 SECONDS:

SITUATION	PLAY CLOCK	REFEREE SIGNAL
Administration of a penalty	25 seconds	Chop or Wind
At the start of a period	25 seconds	Chop
Measurement	25 seconds	Chop or Wind
Offensive (Team A) Helmet Off	25 seconds	Chop or Wind
Offensive (Team A) Injury	25 seconds	Chop or Wind
Defense (Team B) Awarded a First Down	25 seconds	Chop
After All Field Goal, Punt or Point After Touchdown Plays	25 seconds	Chop
Start of a Team's Possession in an Extra Period (OT)	25 seconds	Chop
Inadvertent Whistle	25 seconds	Chop or Wind
Timeout by Either Team	25 seconds	Chop
Timeout by Official	25 seconds	Chop or Wind
Touchback	25 seconds	Chop
Period Extension	25 seconds	Chop

If the R wants the play clock reset, regardless of whether or not it is running, he will signal the play clock operator to restart the play clock. For 40-seconds, the referee will signal with both palms open in an over-the-head pumping motion. For 25-seconds, the referee will signal with one open palm in an over-the-head pumping motion. There is usually no need to stop the game clock to reset the play clock unless the play clock operator does not reset upon the R's signal. The play clock should be reset to 25-seconds when, through no fault of the players, the ball is not ready for play and the play clock has run down below 25-seconds.

SECTION 8. USE OF BEAN BAG AND HAT

ARTICLE 1. USE OF BEAN BAG

- A. The bean bag will be dropped on the approximate yard line, herein after referred to as "spot". **DO NOT THROW THE BEAN BAG!**
- B. Drop the bean bag to mark the appropriate spot:
1. When a scrimmage kick ends inbounds. (This marks the Post Scrimmage Kick enforcement spot. Normally, only one official will mark this spot with his bean bag.)
 2. When the covering official actually sees a live ball fumble anywhere on the field. **SEE THE BALL FUMBLED, NOT MERELY LOOSE!**
 3. When a hand-off or backward pass occurs beyond the neutral zone or when there is no neutral zone.
 4. When a Team A player illegally touches a free or scrimmage kick.
 5. When a Team B player intercepts a forward pass, fumble or backward pass between his five yard line and the goal line.
 6. When a Team B player catches a free or scrimmage kick between his five yard line and the goal line.
 7. When necessary to mark forward progress when the runner/passers is driven back.
 8. When the potential Team A passer is tackled behind the line of scrimmage.
 9. When a fair catch signaler muffs the kick but can complete the catch before it touches the ground.
 10. When there is an inadvertent whistle and the covering official marks the spot of the ball at the time of the whistle.

ARTICLE 2. HAT MECHANICS

- ALL**
- A. Use your hat to mark appropriate spots as follows:
1. When an eligible Team A pass receiver voluntarily goes out of bounds.
 2. When an eligible Team A pass receiver fails to return inbounds immediately after being blocked out of bounds.
 3. When a Team A player goes out of bounds during a free or scrimmage kicks.

OPPOSITE SIDE OFFICIAL

- B. 1. Be alert for a hat on the ground.
2. Cover the yard line while calling official reports action to **R** and **U**.

SECTION 9. BALL HANDLING

ARTICLE 1. UIL GAME BALL AND BALL PERSON POLICIES

The following is excerpted from the UIL Manual / Football Plan:

Ball Boys

With the addition of the 40/25 clock to UIL games, it will be extremely important to get the ball on the ground and ready for play as soon as possible. To that end, it will be highly recommended that game balls for both teams be on both sidelines. This means that both teams will either have to count on the opposing team's ball boys to administer their game balls, or that each team will have to place ball boys on both sidelines. Additionally, it is recommended for each team to provide a 'ball retriever' to assist the ball boys. In the ideal situation there would be two ball boys (one for each team) and one ball retriever on each sideline.

It is recommended that ball boys be at least seventh grade students or above (Freshman or JV players would be optimal). Ball retrievers (those who will 'chase' balls that are downfield or that end up on the opposite sideline) could be younger students working in conjunction with the ball boys.

ARTICLE 2. APPROVAL OF GAME BALLS

- R** A. Prior to game, test, certify, and mark game balls from home team and, if they elect to use their own game balls, test, certify and mark game balls from the visiting team

- B** B. Assist **R** in testing game balls; if air pressure in balls is incorrect, adjust as necessary. If balls are received prior to arrival on field for pre-game duties, take over from **R**. Otherwise, ensure Ball Persons have game balls and are ready prior to coin toss.

ARTICLE 3. BALL PERSONS

SCRIMMAGE PLAYS

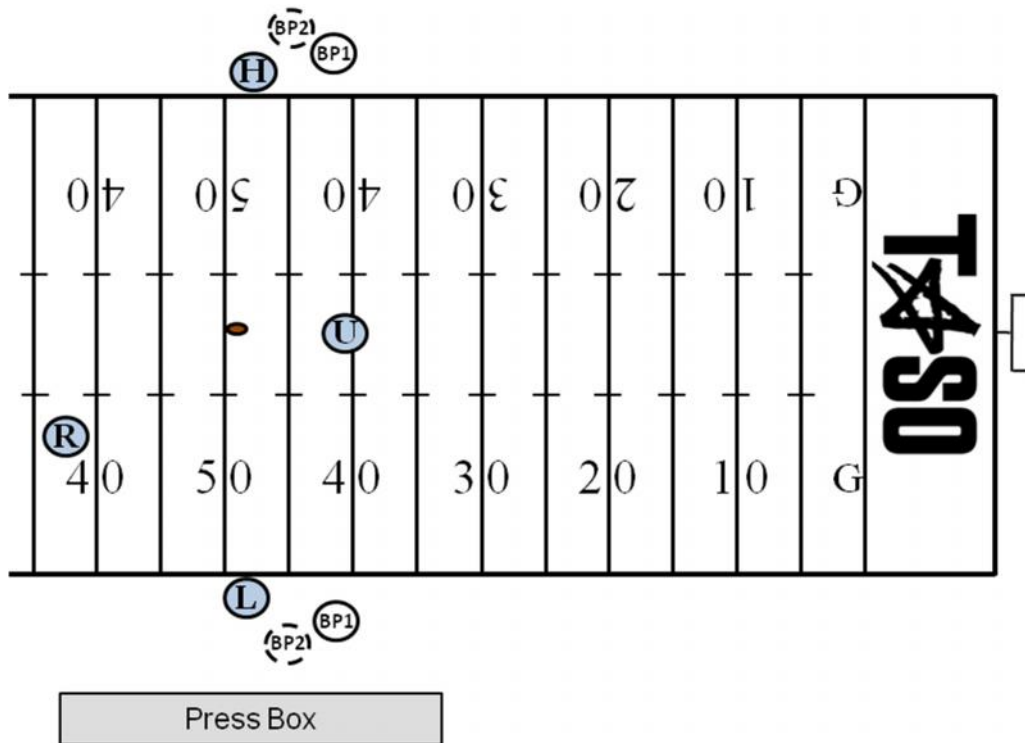

Ball persons (BP) at least 10 yards beyond neutral zone and at least six feet off sideline before snap. If visiting team has ball persons, both ball persons on each sideline shall remain close to each other.

- H, L** A. Meet and instruct ball persons during on-field pre-game period.
1. At least one ball person provided by the home team or game management is to be stationed on each sideline, and shall be responsible for game balls from both teams (unless the visiting team elects to provide ball persons for their game balls - see B below).
 2. (Assuming three game balls per team) Each ball person shall be responsible for two game balls from team on their sideline, and one from opposing team. Each will always be in possession of one game ball from team on opposite sideline, in addition to two (or one) game balls of team on their sideline. When team on their sideline is on offense, one ball from that team will be in game, and one replacement ball will be with ball person on each sideline. Officials and ball persons must coordinate to ensure game balls on each sideline remain 'balanced.'
 3. Ball persons are to remain outside field of play at all times, and be at least six feet off sideline unless relaying replacement ball or retrieving ball that has been replaced.
- Note: Game officials are *solely* responsible for transferring replacement ball to **U** for placement at the succeeding spot; ball persons are to remain off field unless directed to retrieve a ball that has been replaced.

4. For scrimmage plays, ball persons are to be positioned approximately 10 yards beyond neutral zone at the snap, and should move to stay downfield of flank officials as much as possible during play.
 5. Priority is always to get a replacement ball into the game; placing a ball at the foot of the official with forward progress must never delay getting the correct replacement ball into the game.
 6. Following any change of possession, the 'new offense' ball should come from the sideline of team now in possession, regardless at which sideline the dead ball may be, and the replaced ball should be taken to the opponent's sideline.
 7. For field goal attempts and Tries, ball persons are to be positioned at the Team B 10- yard line. *Do not place replacement ball by goal post.* Immediately following play, relay replacement ball to nearest official, then retrieve ball being replaced.
 8. For free kicks, ball persons are to be positioned at the Team B 40-yard line. Immediately following play, ball person on side of team now in possession will relay 'new offense' ball to nearest official, then retrieve ball being replaced.
 9. Ball persons will look for flank official to relay replacement ball into game. Following an incomplete pass, ball person to side where ball falls will look for flank official to that side to relay ball into game.
 10. Ball persons are to remain alert and have correct game ball(s) ready immediately when requested by any official; hustle when retrieving ball that has been replaced,
 11. Ball persons are to toss or hand ball only to officials, and only when requested – *officials and ball persons must get eye contact before tossing/handing ball;* keep all tosses short and underhand.
 12. Ball persons are not to comply with any request by a coach or player to replace the ball; by rule, only the **R** and **U** may determine when a ball is to be replaced.
 13. Ball persons shall not address opposing team personnel in any way; notify nearest official of any interference or unsportsmanlike behavior toward them by anyone.
 14. Ball persons shall be on appropriate sideline and ready with game balls at least three minutes before start of each half.
- B. If visiting team elects to provide ball persons, instruct them as in items A-3 through A-14 above. Additionally:
1. At least one ball person provided by each team is to be stationed on each sideline, and each shall be responsible for game balls from his/her respective team (only).
 2. (Assuming three game balls per team) Ball person on the sideline of his/her team will be responsible for two game balls (for his/her team only). Ball person on opponent's sideline will be responsible for one game ball (for his/her team only). Officials and ball persons must coordinate to ensure game balls on each sideline remain 'balanced.'
 3. All ball persons shall cooperate with and assist each other, regardless of team affiliation.

ARTICLE 4. GENERAL BALL HANDLING

- A. RELAYING BALL – Relaying or transferring of ball should be done quickly and efficiently, with as few exchanges as possible.
- B. SPOTTING BALL – Spotting ball for succeeding down should be done with one placement. Official that spots ball should do so as quickly as practical, yet assuring ball is placed correctly when first spotted. However, any official that has positive knowledge that ball is not spotted correctly should take necessary measures, including stopping clock, to get ball located correctly.
- C. TOSSING BALL – All tosses shall be underhand, with a spiraling motion, and on a generally flat trajectory to chest level of person receiving ball. Do not toss ball over players. A crew proficient in ball handling will not allow ball to fall to ground while handling and transferring it.
- D. START OF EACH HALF OR EXTRA PERIOD – **H** and **L** will have game ball from team on their respective sidelines in hand during the coin toss or option selection. Deliver to **U** game ball from team that will kick-off or snap.

ARTICLE 5. WET WEATHER PROCEDURES

- A. ADDITIONAL GAME BALLS – Teams should provide additional game balls for use in games when wet conditions are expected. **R** must test, approve, and mark all such additional balls prior to the game.
- B. PROCEDURES – Generally the same as for dry conditions, except the flank officials will secure replacement ball from ball persons as needed, and relay to **U**, to ensure dry ball (to the extent possible) is spotted for play for the succeeding down.
- C. TOWELS – **U** should carry a towel to wipe ball dry. After spotting, **U** may cover ball with towel to keep dry. If conditions warrant, **U** may hold ball covered with towel until offense approaches to snap, then spot ball and move to pre-snap position. Other officials may carry towels, if conditions warrant.
- D. BALL PERSONS – Ball persons should have towels to wipe balls dry, and to keep balls covered. Note: By rule, no ball drying substances may be used.

ARTICLE 6. FREE KICKS (Ball Handling)

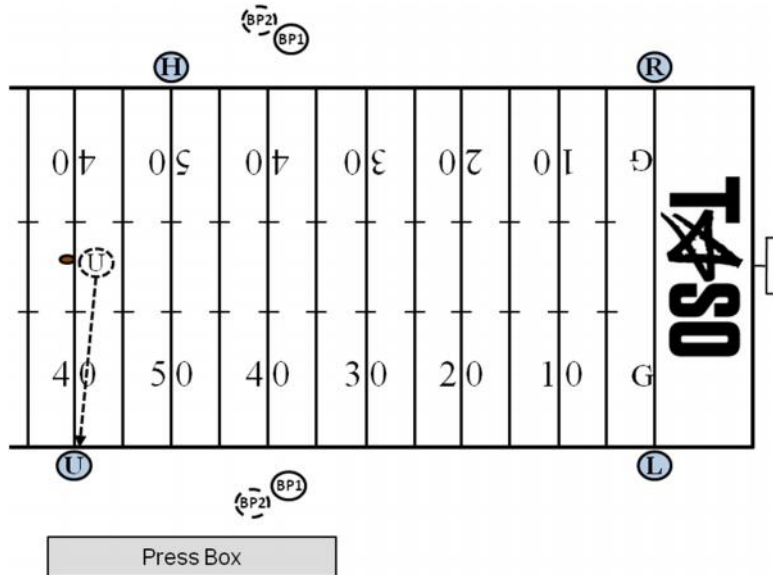

Ball persons (BP) positioned at the Team B 40-yard line (Team A 40-yard line for kick after safety). If team on offense for succeeding play is on L sideline, L will secure 'new offense' game ball from ball person on that sideline and relay to U to spot. If team on offense for succeeding play is on H sideline, H will secure 'new offense' game ball from ball person on that sideline and relay to U to spot. All officials will assist in getting replaced ball to appropriate ball person.

ARTICLE 7. SCRIMMAGE PLAYS (Ball Handling)

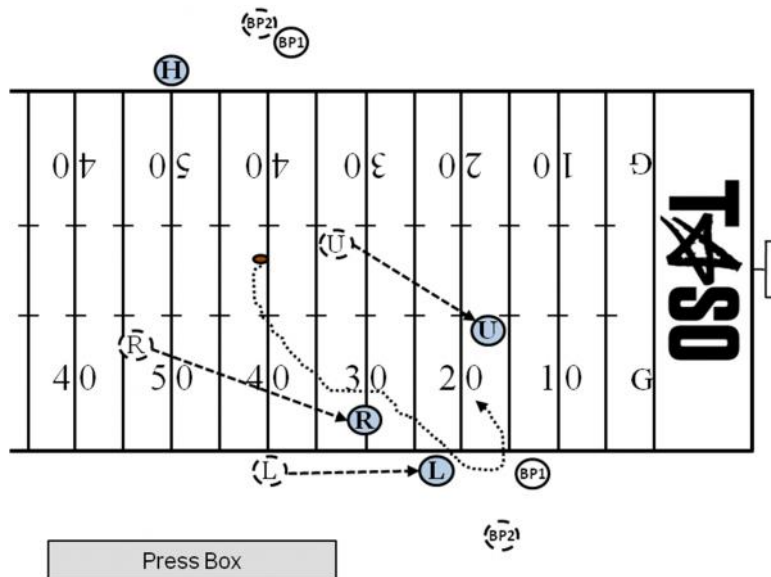

RUN ENDS NEAR SIDELINE OR OUT OF BOUNDS

Ball person(s) move toward Team B goal line as play develops, staying ahead of flank official as much as possible. H / L covers progress of runner as usual. R hustle to sideline area / team area when ball is dead. U moves to a clear area between nine-yard marks and inbounds line, and toward H / L. When there is no threat of foul, H / L secures replacement ball from ball person and relays to U, or R who relays to U.

- ALL** A. When the ball is dead and between the nine-yard marks:
- U** 1. When there is no further threat of foul, move to retrieve ball and place at the succeeding spot.
- R** 2. when there is no further threat of foul, and conditions permit, move to retrieve ball and deliver to **U** to place (or personally place) at succeeding spot.
- B. When ball is dead and nearer sideline than nine-yard marks, or out of bounds:
- H, L** 1. When there is no further threat of foul, secure replacement ball from ball person and relay to **U** or **R**. After replacement ball is spotted, retrieve ball being replaced and toss or hand to ball person, if conditions permit. Ball person may enter field to retrieve ball being replaced.
- R** 2. When ball is dead and in or behind neutral zone and there is no further threat of foul, secure replacement ball from **H / L** and relay to **U**.
- H, L** 3. If you have forward progress, when there is no further threat of foul and conditions permit, secure ball being replaced, or a 'spare' ball from a ball person, and place at foot marking forward progress. *This is to be done only if there is no threat of foul by any player, and if it does not distract any official from performing essential duties.* Assist as necessary in getting replaced ball to appropriate ball person.
- U** 4. Move to an open area between the inbounds line and the nine-yard marks, and toward the flank official; when there is no further threat of foul, permit replacement ball to be relayed to you. Spot replacement ball.
- C. When a forward pass is incomplete:
- H, L** 1. If pass falls to your side of the field, when there is no further threat of a foul, secure replacement ball from ball person and relay to **U**.
- U** 2. Go to side to which pass falls; move to an open area between inbounds line and nine-yard marks, and toward flank official; when there is no further threat of foul, permit replacement ball to be relayed to you. Spot replacement ball.
- ALL** 3. Assist as necessary in getting replaced ball to appropriate ball person.
- D. Following punt or field goal play:
- H, L** 1. When there is no further threat of a foul, secure 'new offense' ball from ball person on sideline of team now in possession and relay to **U**. After relaying ball to **U**, assist in getting replaced ball to appropriate ball person.
- ALL** 2. Assist as necessary in getting replaced ball to appropriate ball person.
- U** 3. Move to an open area between the inbounds line and the nine-yard marks to sideline of team now in possession; when there is no further threat of foul, permit replacement ball to be relayed to you. Spot 'new offense' ball.
- E. When **R** or **U** determine that ball is unfit for play, any official shall obtain a replacement ball from a ball person and deliver to **U**.
- F. Be alert that only game balls marked by the **R** are submitted for use during the game.

SECTION 10. FREE KICKS

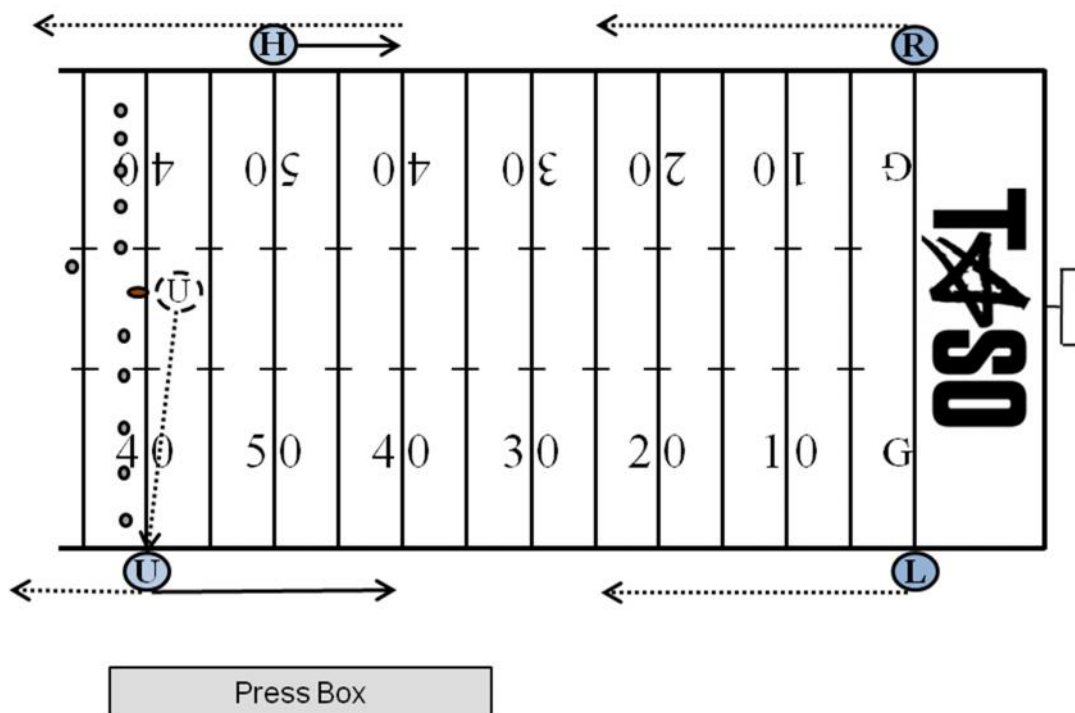

U instructs kicker, moves to sideline at A's restraining line. **L** on press box sideline on goal line pylon. **H** is opposite press box side, on Team B's restraining line. **R** is on sideline opposite press box on goal line pylon.

ARTICLE 1. KICKOFFS

Note: Primary free kick mechanics for 11-player football; alternate for 6-player football, to be used when game conditions dictate.

- U** A. Hand ball to kicker and give him instructions; Caution the kicker to wait for the signal and whistle. Also caution him not to kick the ball if it falls from the tee. Move to position off sideline at A's restraining line. Count Team A players. Check sideline to make sure all non- players are out of the restricted area. Make sure Team A players have complied with the 9- yard mark requirements. When all are ready, indicate by raising and keeping one arm aloft until **R** drops arm and sounds his whistle.
- H** B. Takes position off the sideline opposite the press box at Team B's restraining line. Count Team A players. Check sideline to make sure all non-players are out of the restricted area. Make sure Team A players have complied with the 9-yard mark requirements. When all are ready, indicate by raising and keeping one arm aloft until **R** drops arm and sounds his whistle.

- L** C. Take position off the sideline on press box side on goal line of Team B. Check sideline to make sure all non-players are out of the restricted area. Count Team B players. When all are ready, indicate by raising and keeping one arm aloft until **R** drops arm and sounds his whistle.
- R** D. Take position off sideline opposite press box at the goal line of Team B. Check sideline to make sure all non-players are out of the restricted area. Count Team B players. Obtain all crew members' ready signal and when all are ready, sound your whistle as you give the ready for play signal.
- U, H** E. When ball is kicked, ensure the correct number of players are on each side of the kicker.
- F. Following deep kick, move cautiously downfield outside sideline until ball is in return, then retreat toward A's goal line. Lead runner to A's goal line; be on A's goal line before runner crosses. Observe blocking action in front of runner, if to your side; observe action away from runner if to opposite side.
- R, L** G. If kick goes deep, rule on actions involving the goal line, sideline or end line. If touchback occurs, move into field of play to stop any late or illegal actions but do not ignore players behind you. When ball is in return, remain off sideline and take forward progress of runner.
- L** H. Responsible to observe legal touching and signal clock to start if between your sideline and opposite inbounds line. If ball falls in **R**'s side zone, observe action in front of/around receiver.
- R** I. Responsible to observe legal touching and signal clock to start if between your sideline and near inbounds line. If ball falls in **L**'s area of responsibility, observe action in front of/around receiver.
- ALL** J. If kick threatens a sideline, move quickly to the area to rule. Mark the out of bounds spot, with flag if appropriate, if kick goes out of bounds between goal lines. Maintain position enabling coverage of your sideline at all times. If kicked in your area, cover any muff, advance, or any Team B player who catches or recovers the ball.
- K. Observe any player who is out of bounds before or during the kick.
- L. Signal clock to start if you observe ball legally touched in the field of play.
- M. Observe legality of blocks and action away from the ball when not covering the runner.
- H, U** N. Watch for infractions involving restraining lines. Watch for short kick and whether it is touched or recovered legally or illegally.
- ALL** O. Be alert for fair catch signal and interference with the opportunity to catch a kick. When you do not have the ball, take a position to observe action in your area ahead of the runner.

ARTICLE 2. SHORT FREE KICKS

Note: Primary kickoff mechanics for 6-player football; alternate obvious short free kick mechanics for 11-player football.

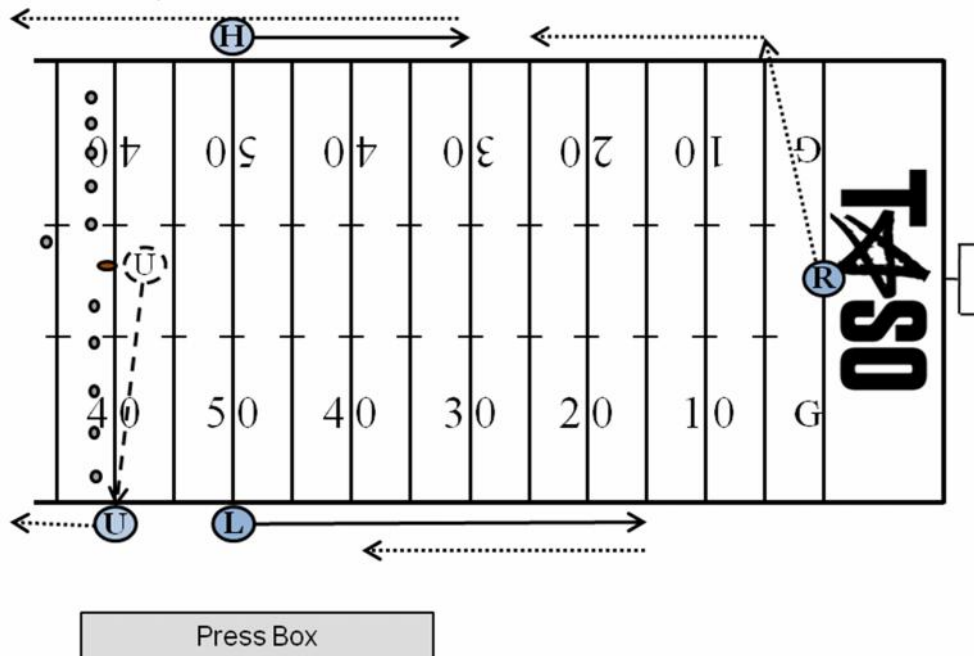

R at goal line, middle of field. *U* hands ball to kicker, gives instructions, moves off press box sideline at *A*'s restraining line. *H* at usual location – off sideline opposite press box, at *B*'s restraining line. *L* off press box sideline, at *B*'s restraining line.

Alternate Short Free Kick Option

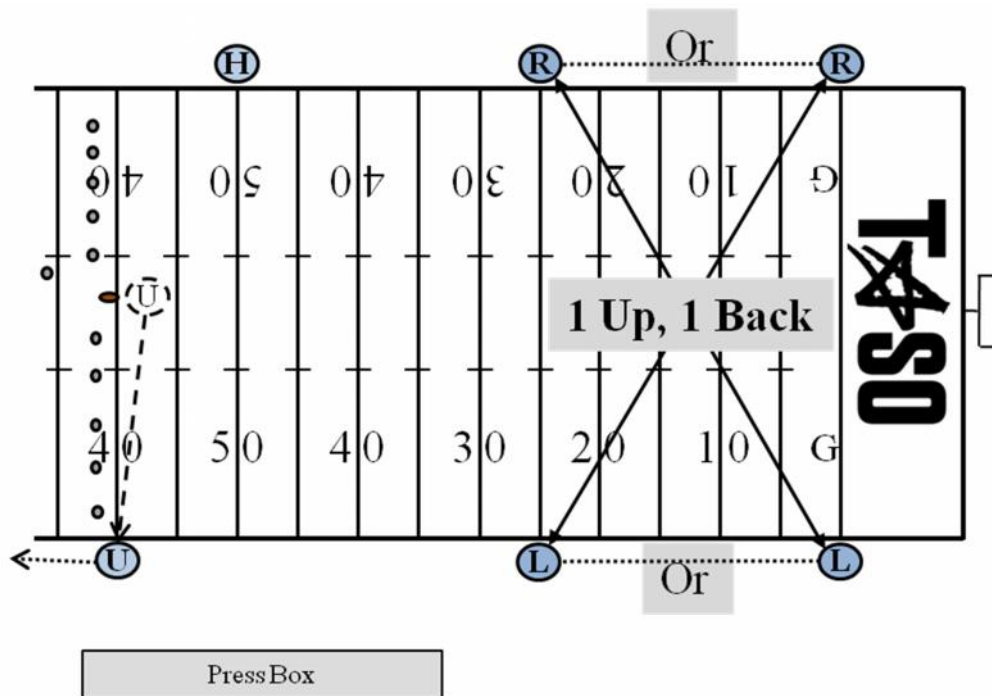

Crews may use a third option in an effort to better cover short free kick opportunities.

*Either the **R** or **L** may move up to the 25 yard line on their side of the field while the other official remains on the Goal line. **H** opposite press box on Team B's restraining line. **U** with kicker, give instructions to kicker and move to Team A's restraining line on press box side. If kick is long, **R** or **L** will retreat to Team B's goal line and assume normal responsibility ahead of runner in his area.*

- R** A. Take position at B's goal line, in middle of field. Count B players; declare ball ready for play *immediately when **U** reaches sideline and signals ready*. At kick, observe for Team A with four players on each side of kicker. Move toward pylon in direction of kick; rule on action involving ball and sideline / goal line / end line. If runback develops, move toward sideline opposite press box, and cover play from off sideline; rule on forward progress.
- U** B. On signal by **L**, hand ball to kicker and instruct kicker to wait for ready-for-play signal from **R**, and not to kick ball if it falls from the tee. Move off press box sideline at A's restraining line; take position and raise hand to indicate readiness immediately. At kick, observe for offside by A, and know if kick strikes ground or is in flight. Observe for illegal blocking by Team A, and assist with action on ball, fair catch signals by B players, interference by A players. If ball is kicked deep, move downfield (off sideline) cautiously, and 'fade' (retreat) toward A's goal line when ball is in return (as regular deep kick).
- H** C. Same duties and positioning as for regular deep kick. Rule on progress of ball, legal touching (start clock), illegal touching by A. If ball is kicked deep, when ball is in return, 'fade' (retreat) toward A's goal line. Assume forward progress responsibility if **R** is unable to get to sideline.
- L** D. Take position off press box sideline at B's restraining line. Clear sideline and count B players. Raise hand when ready. Rule on progress of ball, legal touching (start clock), illegal touching by A. If ball is kicked deep, move downfield quickly and assist with action involving ball and sideline; assist **R** with rulings on actions involving ball and goal line. When ball is in return, rule on forward progress.
- ALL** E. Rule on kick-catch interference, fair catch signals, legal/illegal touches, kicks out of bounds.

ARTICLE 3. FREE KICK AFTER SAFETY

- ALL** A. Assume same relative positions and duties as on kickoff when ball is put in play by either place kick, drop kick or punt.

ARTICLE 4. AFTER TRY OR SUCCESSFUL FIELD GOAL

- U** A. After try or successful field goal, note time, obtain ball of team which is to kick off. Move up the scoring team's sideline to kicking team's restraining line. After 40 seconds have elapsed from the end of the previous down (on **L** signal), instruct the kicker and hand him the ball and move to kickoff position; be in position before the intermission expires.

SECTION 11. PLAYS FROM SCRIMMAGE

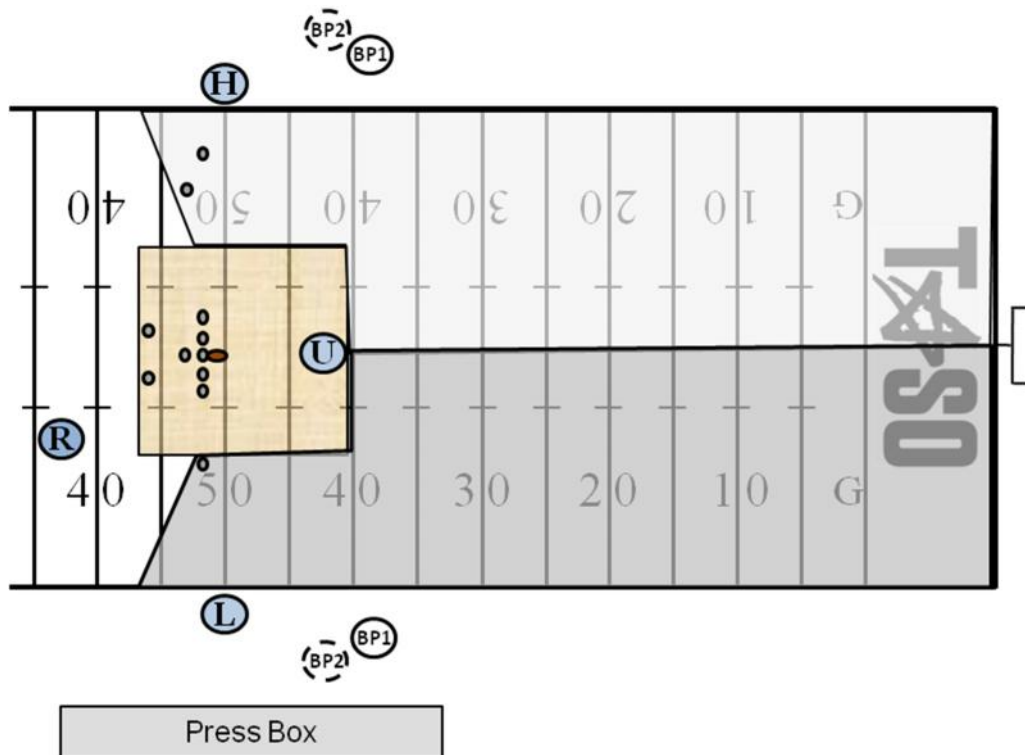

R takes runner sideline to sideline behind line of scrimmage. *H* and *L* watch action on line of scrimmage; take runner in their side zone; responsible for their sideline. *U* watches 5 interior linemen and runner in his area on short drives.

ARTICLE 1. BASIC POSITIONS

- ALL** A. Basic positions may vary, depending upon play situations, team formations, the field and weather conditions. Always box in the play. Avoid positions that may cause scrambling to avoid interference with players.
- R** B. Be in a position 12 to 14 yards deep and 12-14 yards wide from the original position of the ball, where you may comfortably see the ball and backs except flankers, or a man in motion toward you. Usual position on long or open side of field behind the deepest back or backs in position to see the snap. May work on the throwing arm side of the quarterback if desired.
- C. Check the offensive formation and count the offensive players.
- D. Check the set backs and quarterback for illegal motion, the ball at the snap; and assist the **U** if there is movement of restricted linemen.

- U** E. Alignment is variable according to formations of both teams avoiding position which will interfere with linebackers. Adjust distance behind the defensive line according to width of Team A's formation and, except on goal line or try situations be at least five, but seldom more than seven yards deep. Whenever possible coordinate your position with that of the **R** for best coverage of interior line play. Read point of attack and your interior linemen. Know the ineligibleibles and where a forward pass first strikes anything.
- H, L** F. In the neutral zone extended and WIDE, stay out of bounds, off the sideline. Adjust to the formation. Indicate offensive line of scrimmage by an extended foot, don't exaggerate. Take final position astride the neutral zone. Hand signals shall be used to indicate when the Team A player closest to you, on your side, is off the line of scrimmage. If Team A has an unbalanced line, the flank official who has four (or more) linemen on his side may so indicate by putting his open hand to the side of his face.
- G. For a snap at your inbounds line, be out of bounds, off the sideline.
- H. Responsible for legality of motion man whenever he is on your side of the snapper (in any) direction) at the snap. **DOES NOT RELIEVE OPPOSITE OFFICIAL FROM MAKING OBVIOUS CALL!**
- I. Be aware of the importance of assisting **R** in marking forward progress behind the neutral zone, particularly when goal line is involved.
- J. Flank officials must be aware of all wide players to their sides blocking back toward the ball (possible illegal block below waist, clip, etc.).

SECTION 12. RUNNING PLAYS

ARTICLE 1. REFEREE

- R**
- A. **R** is responsible for the ball and the runner and action around him to the neutral zone. If the action is not in the direction of your original position move toward or parallel to the scrimmage line, maintaining position approximately in line with the runner's progress. Close in on the ball when it becomes dead. If in the direction of your position be deep enough so you do not have to step back to allow necessary clearance and then move toward or parallel to the scrimmage line, maintaining a position approximately in line with the runner's progress. Close in on the ball when it becomes dead and there is no threat of a foul. If the ball is thrown, with help from **H/L**, rule whether if it is backward or forward. When the runner in the side zone reaches the neutral zone, turn him over to the **L** or **H**. Responsible for forward progress spot behind the neutral zone and out of bounds spot behind the neutral zone. Observe players and give support on sideline plays. Cooperate with **U** on spotting ball. Quick handoffs that result in short yardage gains will be the responsibility of the **U** or flank officials with the **R** concentrating on action behind the ball. When the quarterback turns up field with the ball, assume responsibility for the "pitch man", until there no longer a threat of a foul. On plays into the line, if runner is driven back after forward progress is stopped, retrieve ball from runner and relay to official covering spot.
- B. On out of bounds runs, especially in team areas, move into dead ball area and assist flank officials with maintaining order. The presence of another official stops most dead ball fouls in the team areas. Some out of bounds runs may necessitate coming rapidly into the team area while observing all action. Go where the play makes you go.

ARTICLE 2. UMPIRE

- U**
- A. Position prior to the snap should be approximately a yard back of and to the side of, or between the linebackers, so that ball and all interior linemen can be seen. Under normal circumstances **U** should be opposite the tight end. **U** will vary position and ensure that the players cannot be sure of his position on each play.
- B. Just prior to and at the snap **U** will be certain the defensive team does not use words or signals which obviously disconcert their opponents when they are preparing to put the ball in play. **U** should be in position to see the snap and rule on illegal movement of lineman or ball. **U** is responsible for the legality of the snap with assistance from the **R** and flank officials. **U** continues to observe his area of responsibility as long as there is a threat of action.
- C. When play develops in his direction, **U** will read the ineligible pass receivers on the line of scrimmage. When a hole opens, he should move away from it as nearly laterally as possible. **U** should check for illegal use of the hands and holding and other fouls by both offensive and defensive players in his area.
- D. As the play develops between the tackles, **U**'s primary responsibility to cover the action of players at the point of attack, then behind the ball and finally around the runner.

- E. On short, quick runs through the line, between tackles in close formation, **U** generally will sound his whistle when the runner's forward progress stops directly in front of him, on his side of the line of scrimmage. **U** always takes forward progress from the flank officials.
- F. When the runner moves into the side zone, **U** will clean-up the area between his position and the ball. **U** may, if necessary, move in near the sideline when he is needed to give proper coverage of the action; go where the play makes you go. When the ball is in the side zone, **U** is in position to observe action away from the ball and around the runner from an inside-out position. When the play is over, all officials have responsibility to rule on late blocks and other illegal acts.

ARTICLE 3. HEAD LINESMAN & LINE JUDGE

- H, L**
 - A. Initial position should be out of bounds, off the sideline. NEVER TURN YOUR BACK TO THE BALL. Cover the runner in your side zone beyond the line of scrimmage and out of bounds. Mark forward progress with down field foot, extended slightly toward the spot, don't exaggerate. When marking forward progress, converge rapidly on the dead ball spot when play in your area permits. Be alert to cover forward progress spot when runner has been thrown back. Work the ball as needed.
 - B. Observe initial charge on your side. You are responsible for blockers and action on ends and linebackers on your side. Pick up runner when he crosses the neutral zone in your area. Spot ball on quick thrusts and close line plays. If play goes away from you, observe action behind runner and assist with action on the pitch man if he does not receive the ball. Maintain a position in relation to the runner's progress observing the play behind the **U** and in front of the wing official. Be alert for the runner returning to your area.

ARTICLE 4. ALL

- A. Watch for fouls by blockers leading the runner and for fouls after ball is declared dead. The use of signal #7 to indicate dead ball should be used only by **R** when fouls are involved.

SECTION 13. FORWARD PASSES

BASIC POSITIONS AND AREA COVERAGE

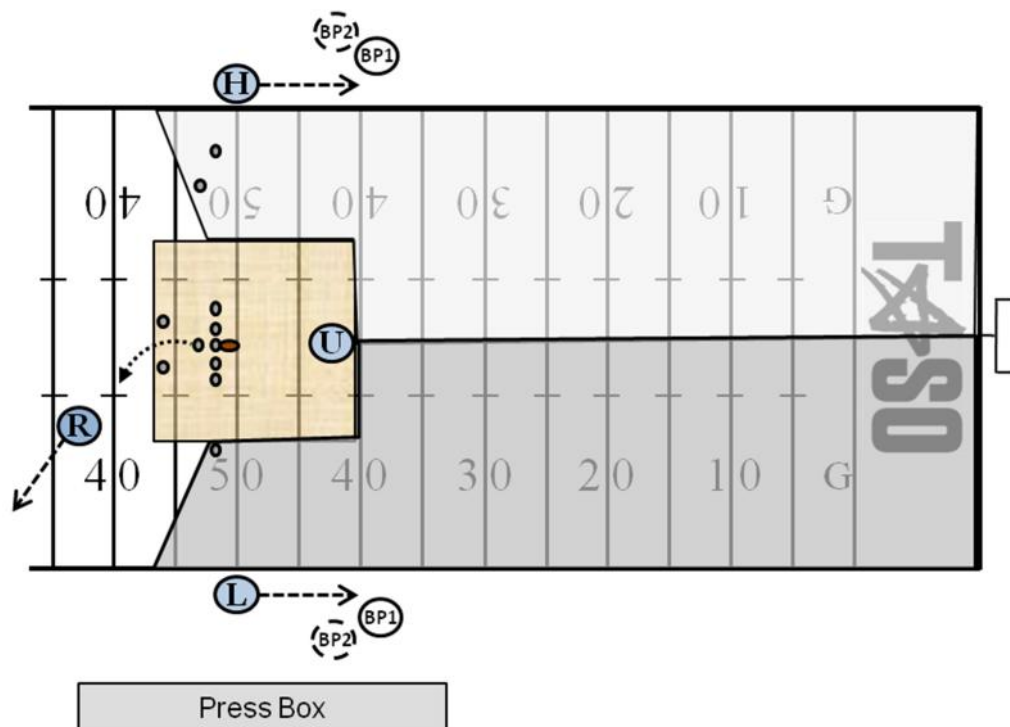

R takes ball, QB and tackle on his side of field. **U** takes same position as if a run, five to seven yards off the ball. **H** and **L** are positioned astride neutral zone, near or outside sideline.

ARTICLE 1. REFEREE

- R** A. When passer retreats, remain wide and deeper than the potential passer. **R** is solely responsible for intentional grounding. He may consult with other officials on the position of eligible receivers. Remain behind line to observe legality of the throw and action against the passer. After the passer throws the ball, continue to observe him until there is no threat of a foul. Ensure that passer is not roughed or thrown roughly to the ground. Verbally alert defenders when passer has released the ball. Continue to observe offensive and defensive action behind the line before moving out of the area. Other officials will cover play downfield. With help from the **H/L**, determine whether pass is forward or backward and give appropriate signal. Move to spot of pass; if illegal, drop flag while continuing to officiate.
- U** B. Check legality of numbers of interior offensive linemen at the snap. Observe action of players on and directly behind the neutral zone, illegal advance of ineligible and assist with trapped and buttonhook passes. When **U** reads a forward pass play, he should step toward the line of scrimmage. This removes him as a target and opens up his area for shallow drag-pass patterns. This position permits **U** to observe linemen moving illegally downfield. After observing play of linemen and their contact with up blocking backs, pivot to assist on low trajectory and short passes over the center of the line. Know where ball first touches anything on forward pass. Use signal #11 when appropriate. Assist **R** in determining legality of forward passer.

ARTICLE 3. HEAD LINESMAN, LINE JUDGE

- H, L**
- A. Assist **U** in checking the legality of numbers of offensive interior linemen. Check legality of positions for players with eligible numbers. After initial charge of linemen, move into position to check blocking and contact of eligible receivers and linebackers. Be ready to rule on the direction of a quick quarterback pass. The covering official, toward whom the ball is thrown, should signal, by extending one arm horizontally in the direction of the passing team's goal line, if the pass is ruled backward. Drift downfield cautiously for the first 5-7 yards, approximately halfway between flat zone and deepest receiver. While pass is in flight, move to the most advantageous position to judge the play. Always be prepared to come back to rule on play near the neutral zone in addition to sideline action. Observing the wide initial position is helpful in covering any pass. If potential passer decided to run, you must cover him beyond the neutral zone. Entire sideline is your responsibility. Opposite sideline officials should assist with forward progress spots if the covering official is not in position to rule.
 - B. After an incompleteness, obtain ball from ball person and form a relay to return the ball to official nearest the previous spot.
 - C. If an airborne player receives a pass near the sideline and first returns to the ground out of bounds, after giving the incomplete signal, the covering official may, with both arms, give a sweeping motion toward out of bounds.

ARTICLE 4. ALL

- A. Be alert for an illegal pass, especially after a completion, observe touching or catching by an ineligible player. Watch particularly for holding or illegal contacting eligible receivers and all contact beyond the neutral zone both before and after the pass is thrown. Observe action when opposing players contest for the pass. When ruling on pass reception involving the sideline, only the signal governing should be used. Repeat signal three times. After an incompleteness, obtain a ball from a ball person and form a relay to return ball to official nearest the previous spot.
- B. When contact occurs on a pass that is uncatchable, and the covering official does not drop his penalty marker, the covering official will give the uncatchable pass signal. (S17)

SECTION 14. GOAL LINE PLAYS

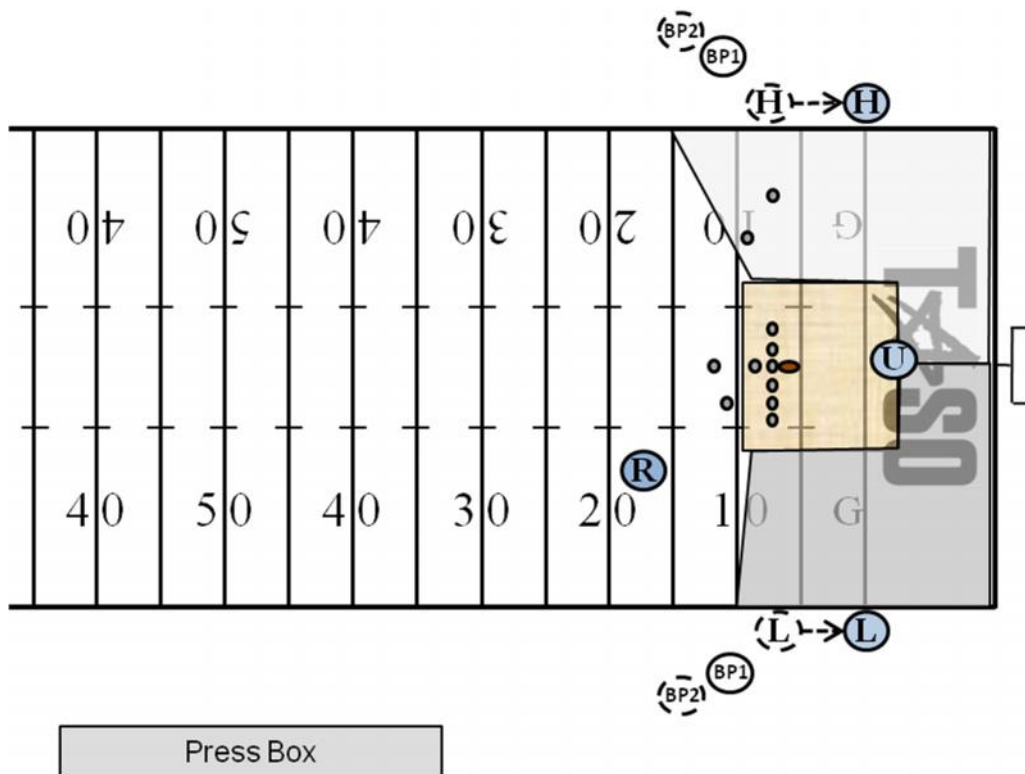

Except when a field goal attempt is indicated on a try, the crew will set up as on any other short yardage down. (See Section 17 for Field Goal Attempts)

ARTICLE 1. GOAL LINE (Ball snapped on or inside B's 10-yard line)

- R** A. Position and coverage the same as for other scrimmages with the forward point of advancement usually determined by the flank official. Signal score only after being positive all requirements are met.
- U** B. Ordinarily need not be as deep as for other scrimmage plays. When runner has made quick thrust into the line at your feet, be sure the ball is not moved forward after it is declared dead. Never signal score but assist the **L, L**, verbally or visually; they will signal score.
- H, L** C. Initial position must be wide out of bounds, off the sideline. When snapped at or inside the 5 yard line, move toward the goal line and rule on the score. Work back to the ball to establish forward progress. Be alert for a forward pass.
- H, L** E. If ball's forward progress stops short of the goal line, move in on the ball, mark and **U** hold the dead-ball spot until ball is spotted for the next play.
- ALL** F. Indicate score by touchdown signal only when in position to determine same, being positive that requirements are met.

SECTION 15. FUMBLES

ARTICLE 1. SIGNALS

- A. The nearest official should point in the proper direction, no matter who recovers. R will then signal the next down when he makes the ball ready for play.

ARTICLE 2. DIGGING OUT FUMBLES

- A. Should it become necessary to "dig it out", the nearest official should dig for the ball, the next official to the area should signal to stop the clock and look to the clock to ensure it is stopped. The stop the clock signal should be relayed by the remainder of the crew. When the digging official determines possession he should verbally relay possession information to the nearest standing official, normally the **R**, who will then signal the proper direction. If possible, the signaling official will point to the recovering player to assist the press box. Only the **R**, if he is not the signaling official, should relay the direction signal. See Section 8 for bean bag mechanics on fumbles.

SECTION 16. SCRIMMAGE KICKS

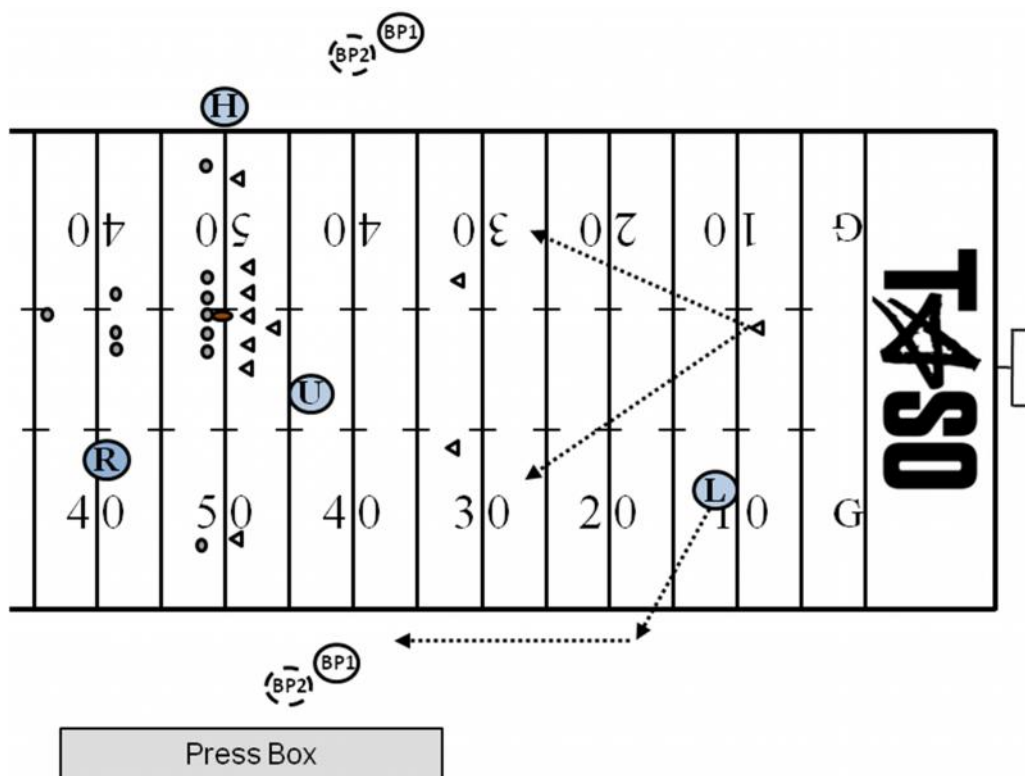

R watches play on kicker, *H* holds until ball crosses neutral zone, then moves downfield covering on his side between line of scrimmage and deep receiver(s). *L* takes a position slightly ahead of receiver(s). *U* takes position toward *L* sideline. *H*, know if kick crosses neutral zone; be alert for blocked or partially blocked kick.

ARTICLE 1. BASIC POSITIONS AND COVERAGE

- R**
- Takes position at the side of the kicker, wide enough to see the ball from snap to kick. Be able to see blockers and kickers at the same time. Be in position to be even with, or slightly in front of the kicker when ball is kicked. Adjust to the situation; warn potential kicker if he is on or outside the end line prior to the snap.
 - When it is obvious a kick will take place and there is not a player 10 or more yards behind the neutral zone, the R will place an open hand on his chest, indicating to the U that Team A is not in a legal scrimmage kick formation.
- R, U**
- Count offensive players.
 - Be alert for delay by kicking team to confuse opponents.
- U**
- Adjust to field position 4-7 yards deep favoring the *L*'s side of the field. Face the offensive line during the initial charge, observing the action of Team A and Team B players. Observe defensive man over center. Avoid serious injury to the snapper. Shift observation to contact between defensive players and protectors

behind the line. After players move past your position, turn and move toward the return area to observe for illegal action by players of either team. Be alert for sleeper plays. If the kick is short, or partially blocked, be alert to determine if it crosses the neutral zone.

- H** F. Same as for runs and passes. Check offensive linemen for on or behind the line and for an unbalanced line.
- L** G. Take position outside and in front of deep receivers on your side of the field. Count receiving team. Adjust to play area and assume responsibility for coverage into either sideline.

ARTICLE 2. AFTER THE SNAP

- R** A. Watch blocking and illegal action by players behind the line. Observe action of and against the kicker, using signal #11 if appropriate, and observe players while proceeding slowly downfield if the kick remains inbounds. If the flight of the kick is toward a sideline, move quickly to position in line with the flight and use arm signals to direct the official covering that sideline to out of bounds spot. When correctly aligned, drop your arm as indication that the official hold the spot until ball is spotted for next down.
- R, U, H** B. Be alert for blocked kick. Be alert for recovery and advance.
- U** C. Look down the line at the initial charge, checking blocks of offense and action by defensive players. Observe defensive linemen over center to avoid serious injury to snapper. Shift observations to contact between defensive players. After players go past your position turn and move toward the return area, observe the center picture for illegal action by players of either team, assist with substitutes. Be alert for sleeper plays.
- U, H** D. If the kick is short or partially blocked, know if it crossed the neutral zone.
- H** E. Primary responsibility to know if kicked ball crosses neutral zone.
- F. After initial line charge, observe blocks for defensive holding. If the kick is short to your side, observe first touching, legal or illegal, catch interference, valid or invalid signal for fair catch. Maintain position to cover in front of the runner after catch or recovery of the kick, maintain coverage until the runner cuts toward the opposite side or, if on your side, is picked up by you. You have responsibility for the entire sideline on your side.

ARTICLE 3. AFTER THE KICK

- R** A. Drift downfield but do not pass any players – keep all action in front of you. If runback develops, retreat quickly to lead action to A's goal line. Be on goal line before runner crosses; observe action of blockers in front of runner.

- U** B. As linemen pass you, turn and continue to observe blocking action; drift cautiously downfield. If runback develops, maintain inside-out position, but begin moving toward A's goal line to stay with action on and around runner.
- L** C. Observe action in front of the ball. Observe first touching, interference, and fair catch situations. Cover kicks on ground or in air which go 25 yards or more. If in doubt as to spot of out of bounds kick in the air, raise hand and **R** will assist. If there is any question regarding covering official, communicate verbally. Use signal #11, foul marker, or spot marker (bean bag) when appropriate.
- D. After kick is caught or recovered, move quickly to your sideline and cover progress of runner. You have entire sideline.
- H** E. If kick is short to your side, take responsibility for ball and be alert for first touching (legal or illegal), catch interference, valid or invalid fair catch signal(s), and end of kick. Use signal #11, foul marker, or spot marker (bean bag) when appropriate.
- F. If kick goes to side opposite you, drift downfield, observing all action and be alert for a sudden cut toward your side and possible exchange in coverage of the runner. When you do not have the ball, take a position to observe action in your area ahead of the runner.
- H, L** G. Mark and hold out of bounds spot of rolling kick on your side. Be alert to cover and accept **R**'s signal in spotting out of bounds kick in flight.
- H. **L** will be primarily responsible for ruling on fair catch signal in his area. **H** observe other action surrounding the ball. If player signaling fair catch does not touch the ball, **H** must observe legality of his actions until the ball becomes dead. Be ready to rule on kick in end zone. Be alert for batting. Use a bean bag to mark the spot where kick ends.

SECTION 17. TRY AND FIELD GOAL PLAYS

ARTICLE 1. ATTEMPTS ON/OUTSIDE B's 15-YARD LINE

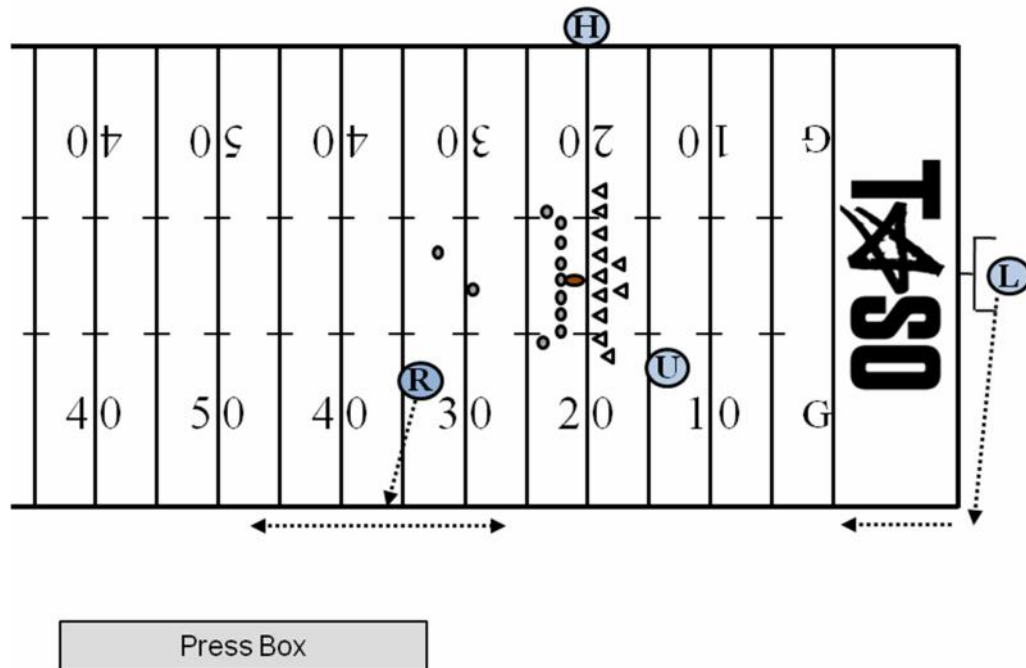

On attempts from on/outside B's 15, **R** to **L** side, **U** to **L** side, **H** in normal position, **L** at goal.

- R**
- On a try or field goal, on or outside the 15-yard line, **R**'s position is a yard or so to the rear and several yards to the side of the potential kicker, (favoring the **L** sideline), facing the kicker where **R** can see the ball when spotted for the kick and from which position **R** observes the two guards and the center within his line of vision. Covers as usual if a run or pass. Assist in sideline coverage if run develops to vacated **L**'s side. Signal score after being positive that requirements are met. Rule on roughing or running into the kicker and/or holder.
 - When it is obvious a kick will take place and a potential holder and potential kicker are not seven or more yards behind the neutral zone, the **R** will place an open hand on his chest, indicating to the **U** that Team A is not in a legal scrimmage kick formation.
- U**
- Take position favoring **L** side. Responsible for action on or by two offensive linemen and up blocking back favoring the vacated **L**'s side. Shift observation to contact between defensive players and protectors behind the line. After players go past your position, turn and move toward play to observe the entire picture for legal action by players of either team. Assist in goal line coverage if run develops to vacated **L**'s side. Be alert for the snapper being fouled.
- H**
- Assume normal position as for any scrimmage play. Responsible for legality of snap and entire line of scrimmage. Quickly move to goal line if run develops.

- U, H** E. If the kick is short or partially blocked, know if it crossed the neutral zone.
- L** F. Take position slightly behind end line, in center of goal. Responsible to rule on success or failure of field goal attempt. Responsible for action involving end line. If run develops to your vacated side, quickly move along back line to back pylon to rule on the sideline. Next move is toward goal line to assist. If run situations develop to your side, you have primary sideline responsibility with **R**'s assistance. If attempt is short and ball remains alive, give no signal, officiate as a scrimmage kick. Sound whistle when ball becomes dead on attempted field goals.
- G. When the field goal attempt narrowly passes outside an upright, the **L** may give a sweeping motion with both arms away from the upright.
- ALL** H. All officials should be alert for runbacks. Assist each other in getting ball spotted for next down.

ARTICLE 2. ATTEMPTS INSIDE 15-YARD LINE

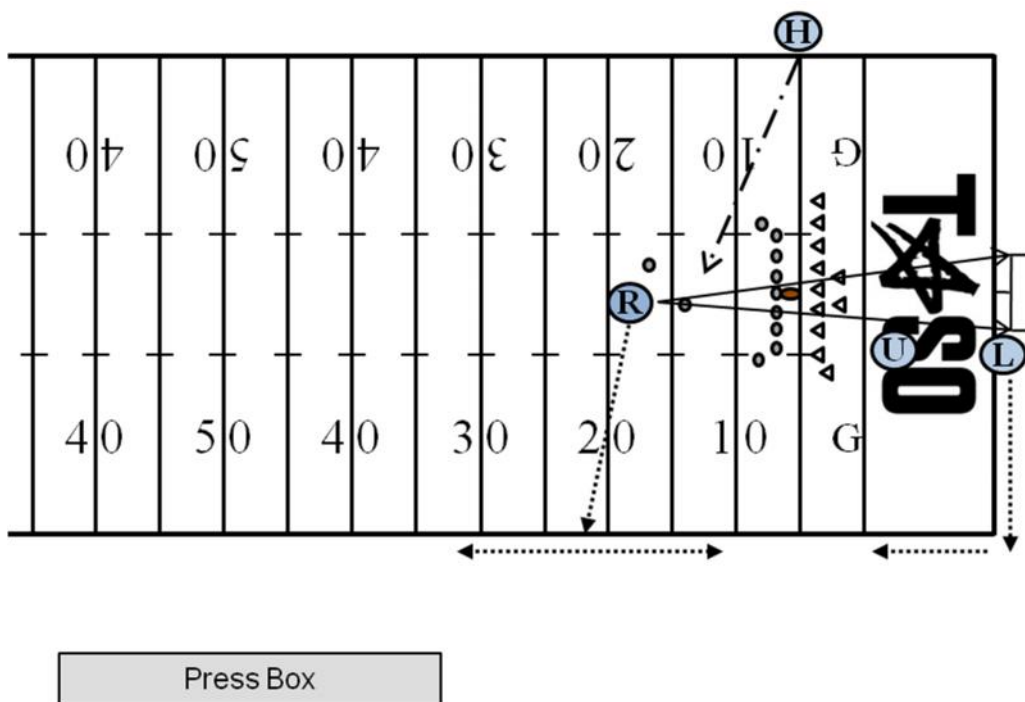

*On attempts inside B's 15, **R** behind holder, **L** on end line, at inbounds line extended.*

- R** A. Take position behind holder; adjust to be in position to see snap, hold, and path of kicked ball to goal. Rule on success or failure of field goal attempt passing between uprights of goal.
- B. If run or pass play develops, move quickly to **L**'s sideline to assist with action involving sideline, and progress of ball or runner.
- U, H** C. Assume duties as for field goal attempts outside 15-yard line.

- H** D. Assume normal position as for any scrimmage play. Responsible for legality of snap and entire line of scrimmage. Quickly move to goal line if run develops. Rule on roughing or running into the kicker and/or holder.
- L** E. Take position on end line at inbounds line extended. Responsible to rule on success or failure of field goal attempt passing over crossbar (*only*; R rules on ball passing between uprights). If kick is successful, give no signal. If kick fails to pass over crossbar and becomes dead immediately by rule, look to R and give "no score" signal (#10). If attempt is short and ball remains alive, give no signal, officiate as a scrimmage kick. Sound whistle when ball becomes dead on attempted field goals.
- F. If run develops to your vacated side, quickly move along back line to back pylon to rule on the sideline. Next move is toward goal line to assist. If run situations develop to your side, you have primary sideline responsibility with R's assistance.

ARTICLE 3. TRY ATTEMPTS

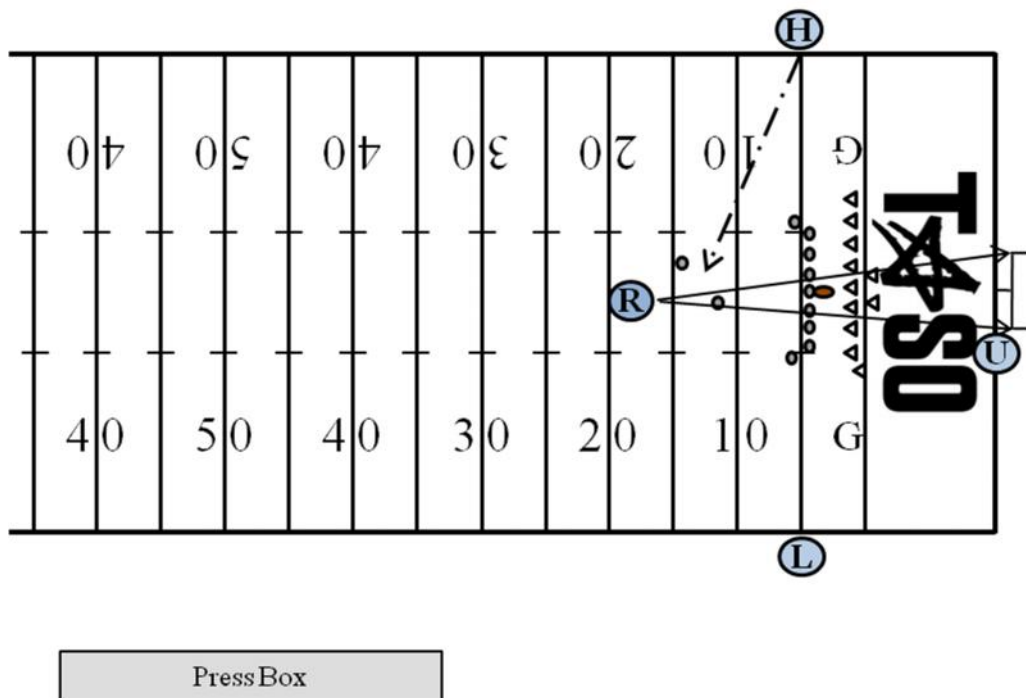

On TRY attempts only, R behind holder, U on end line, at inbounds line extended. L and H on line of scrimmage.

- R** A. Take position behind holder; adjust to be in position to see snap, hold, and path of kicked ball to goal.
- B. Rule on success or failure of field goal attempt passing between uprights of goal.

- H** C. Assume normal position as for any scrimmage play. Responsible for legality of snap. Rule on roughing or running into the kicker and/or holder. Quickly move to goal line if run develops.
- L** D. Assume normal position as for any scrimmage play. Responsible for entire line of scrimmage, including action on the center. If the kick is short or partially blocked, know if it crossed the neutral zone. Quickly move to goal line if run develops.
- U** E. Take position on end line at inbounds line extended. Responsible to rule on success or failure of field goal attempt passing over crossbar (*only*, R rules on ball passing between uprights). If kick is successful, give no signal. If kick fails to pass over crossbar and becomes dead immediately by rule, look to R and give “no score” signal (#10). If attempt is short and ball remains alive, give no signal, officiate as a scrimmage kick. Sound whistle when ball becomes dead by rule.
- ALL** F. Officiate all try downs as a normal scrimmage down and do not sound whistle until ball is dead.

SECTION 18. TIME OUTS

ARTICLE 1. PROCEDURES

- R** A. Indicate a full length charged time out by facing the Press Box. Give time out signal then extend one arm in pointing fashion, horizontally, in direction of requesting team. Indicate a third charged time out by following this signal with three tugs on an imaginary steam whistle.
- B. Check with **U** the number of time outs charged to each team and the playing time remaining in the period.

THIRD CHARGED TIME OUT

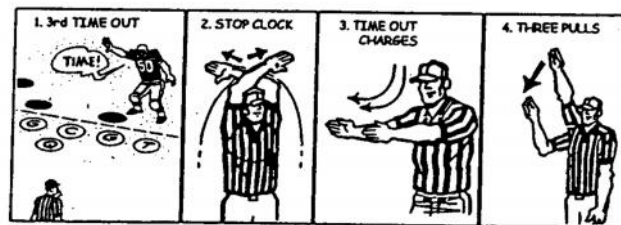

- C. Notify the head coach when his team's time outs are exhausted.
- H, L** D. Notify a coach from team on your sideline of the number of time outs remaining to each team and of the remaining time in the period.
- ALL** E. When relaying the number of time outs, relay the number the teams have remaining.
- R** F. Quickly take position, well clear of officials and players, and be ready to handle any emergency.
- G. Upon **L**'s signal that the time-out interval has expired, or when both teams indicate readiness to resume before that time, direct teams to prepare to resume play. Go to position, get ready signals from each captain, and declare the ball ready for play within five seconds.
- ALL** H. Record time left on clock and number of requesting player when charged team timeout is requested. Do not huddle unless necessary.
- H, L** I. Take a position halfway between your team and its team area. Direct teams to prepare to resume play upon signal from **L**.
- J. Check number of players in your team's huddle. Repeat this check after taking position for the next down. **H & L** are responsible for teams on their side.
- U** K. Quickly take position over the ball. Remain over the ball until released by **R**.

- L** L. Time the one-minute time out interval. When 20 seconds remain in the interval, sound your whistle three times, short but sharp. Move to your position and give a visual signal to the **R** when the interval expires. Be alert to assist **R** if needed.
- M. Check time remaining.

ARTICLE 2. REFEREES TIME OUT

- R** A. Signal time out, then indicate **R**'s time out by tapping chest with hands. Stay at the ball.
- B. Only **R** may stop the clock for a coach's conference. If the coach is not correct on his reason for requesting a coach's conference, he will be charged with a time out. After the time out has been charged to the coach, the procedure for a team time out will be carried out. This includes a full time allotment.
- C. Signal time out when Team A is awarded a first down.
- D. Declare ball ready for play as soon as need for time out has been met.
- ALL** E. Signal time out and carry out usual duties.
- F. When either team is in possession of the ball in advance of the line to gain, covering official indicates time out.
- G. If game is disrupted for any reason, record down, team in possession, position of the ball and time remaining in the game.

ARTICLE 3. INJURY TIME OUTS

- ALL** A. Same as free time out (limited). Permit as much time as is necessary. SAFETY OF INJURED PLAYERS IS MOST IMPORTANT. Use signal #3, followed with tapping hands on chest.
- B. Do not allow players to assist teammates but direct that they wait for trained staff.
- C. **R** may permit water attendants to tend to their teams on the field during extended injury timeouts.

SECTION 19. MEASUREMENTS

ARTICLE 1. PROCEDURES

- R**
- A. When spotting the ball after each scrimmage, be sure there is no need for measurement before announcing the down. If close, announce the down and be alert for either captain's request for measurement, if doubtful, call for measurement without captain's request.
 - B. Clear the area of officials and players for press box view; assist **U** in ensuring ball is not moved.
 - C. When the ball becomes dead in a side zone or out of bounds and measurement should be at the dead ball spot, have covering official place the ball at the proper spot. If short of a first down, use the forward point established on the chain when spotting the ball at the inbounds line. If alternate game ball is available following the measurement, leave the ball in the side zone until an alternate ball is placed at a corresponding inbounds spot.
 - D. See that the **U** is ready. Observe the relative position of ball and point to be gained, then announce your ruling.
 - E. Remain over the ball and announce down and distance. Get ready signals from captains while **H** is resetting chain. When **H** is ready, declare the ball ready for play.
- R, H, U**
- F. Check for kinks in chain and be sure that chain is taunt.
- U**
- G. Will ensure the ball is not moved after being spotted for measurement. Take forward rod. Wait until **H** calls "ready" then carefully tighten the chain only once. Don't pull or jerk it. Have the rod perpendicular to the ground at the side of the ball until **R** announces his ruling, then return rod to the chain crew.
- L**
- H. Go to yard line nearest rear stake. Mark a spot perpendicular to the ball to aid **H**. Also, aid **H** in positioning the chain for an accurate measurement. When chain is set for measurement, secure replacement ball for **R**, for spotting at inbounds line if not a first down. Assist **R** & **U** in keeping area clear of players, for press box view.
- H**
- I. Grasp chain at point of its intersection with the back edge of the marked yard line nearest the rear rod. After clip of snap is affixed to mark the correct point, grasp the chain firmly as assistants carry it to the position on the field. Instruct the box operator to place the box at the nearest rod, maintaining the previous down.
 - J. Maintaining grasp, place the correct point of the chain on the back edge of the proper yard line, call "ready" and be sure the chain is not jerked from your grasp when tightened by the **U**.
 - K. If not first down, retain firm grasp and personally set the chain at its original spot on the sideline. Check the point marked by your assistant.

SECTION 20. CALLING FOULS & ENFORCEMENT



ARTICLE 1. PROCEDURES

- ALL**
- Official calling foul will drop or throw marker at proper spot, mentally marking the yard line. If ball is alive, withhold whistle until the ball becomes dead; then continue to sound whistle until you are certain other officials are aware a foul has been called. The official should then communicate the information to the **R**. For pre-snap fouls, visual signals are acceptable.
 - Know status of ball if it is in play. Make mental note as to whether the clock should be started on the ready or on the snap.
 - Do not place a hand on or point to the offending player. Official who calls disqualifying foul notifies the head coach. Nearest official will notify, by position or number, a coach of non- disqualifying fouls by his team. On encroachment fouls or false start fouls, if more than one marker is down, calling officials should consult with **R** or **U** whichever is appropriate, before reporting foul. If **U** is involved, he should report the foul to the **R**. When giving a sideline warning, throw your flag. Notify head coach, go to **R** and report the violation. Each of you record; let the **R** signal sideline receiving the warning.
 - After calling foul, get **R**'s attention as soon as ball is dead, sound whistle and give verbal description. It is your duty to make sure another official is covering the spot of foul if foul is spot foul; then go to **R** and report the foul fully as follows:

1. Foul called. Always use Who, What, Where, When, Who fouled? Offense or Defense, Return or Kicking team. What was the foul? Where did the foul occur? Behind or beyond LOS. When did the foul occur? Live or dead ball.
 2. Offending team, including jersey color and A/B, offense/defense or kicking team/ receiving team.
 3. Offending player's number or position.
 4. Spot of foul, previous spot, end of run or end of kick.
 5. Status of ball when foul occurred.
- E. Stay clear of spot of foul.
- H, L** F. Foul called by another official:
1. If ball is not at dead ball spot, assist in getting it there.
 2. Cover and hold dead ball spot and mark end of run. Leave ball on ground until called for.
 3. If foul is spot foul, cover and hold spot of foul.
 4. If all spots are covered, including penalty marker, observe players and assist where needed.
- H, L** G. Covering Spot Of Foul:
1. Hold spot as long as necessary. Ascertain foul and offending team. When **U** starts to enforce the foul, pick up marker of official who called foul.
 2. If enforcement spot is different from spot of foul, see that it is covered by an official.
 3. If enforcement is from spot of foul, **L** shall hold spot during enforcement. **U** will release him.
 4. When fouls are committed that require enforcement at the spot of the next free kick, **R** will give the preliminary signal and point to the next free kick spot. **U** will repeat the signal following enforcement from the succeeding spot.
- R** H. When foul or fouls are reported to the **R**, he will immediately give preliminary signal or signals to press box side before explaining options to captains. Notify both captains if loss of down is part of the penalty. Give dead ball signal before giving the signal for a dead ball foul. For pre-snap fouls, preliminary and dead ball signals are not required.
- I. If a choice is obvious, announce it and proceed with enforcement or declination. If captain objects, explain alternatives and conform to his choice. If choice is not obvious, explain foul or fouls and the options, state options briefly, but correctly, clearly and courteously. Notify captain of offending team of foul called and number and position of offending player (if possible). If equipped with a microphone, do not announce the number of the offending player.
- L** J. Hold enforcement spot until penalty is completed. (Exception: Penalties assessed on kickoff).
- R** K. When penalty is to be enforced, instruct **U** as to point of enforcement and yardage to be marked off.

- U** L. Take a position near **R** when he explains options to a captain. If penalty is to be enforced, follow **R**'s instructions in marking off the penalty. **U** will carry ball and place in position when penalty is enforced. Don't step off yardage, use yard line. Verify visually with **H** and **L**.
- L** M. If satisfied with enforcement, proceed to succeeding spot.
- H** N. When **U** starts to mark off penalty, **H** should move in the same direction and distance on the sideline. Check visually with **U**; if enforcement is correct, direct assistants to move down indicator and direct moving of chains if appropriate.
- R** O. While **U** is marking off penalty, take position in clear where you can be seen. Give signal to press box side of the field only.
1. If penalty is accepted, signal foul and extend one arm in pointing fashion, horizontally in direction of offending team.
 2. If penalty is declined, signal foul, extend one arm in pointing fashion, horizontally in direction of offending team and then give the penalty declined signal. (S10)
 3. If penalties offset, signal one foul, extend one arm, in pointing fashion, horizontally in direction of offending team, repeat this procedure for foul by other team, then give penalty declined signal.
 4. While facing press box, indicate the number of the next down.
 5. When fouls are committed that require enforcement at the next free kick, the **R** will give the preliminary signal and point to the next free kick.
- U** P. Cover the ball after completing penalty and **R** is in process of giving signal for fouls.
- R** Q. Declare ball ready for play. Start clock if appropriate.
- L** R. Move auxiliary down indicator, if available.
- ALL** S. Official calling foul is primarily responsible to see that **R** and **U** assess penalty properly in all respects.

SECTION 21. CLOSE OF A PERIOD

ARTICLE 1. PROCEDURES

- ALL** A. Near the end of a period, all officials should be aware of the time remaining before the start of each play. With less than 25 seconds remaining in any period and the game clock running, the 25 second clock shall not run.
- R, U** B. When time expires, sound whistle only if ball is dead. The termination of a period is then indicated by the **R** holding a ball over his head with one hand. The **R** is primarily responsible for determining the end of any period. He should enlist the aid of the **U** when the only field clock is at his back.
- C. At close of first and third periods, see that ball is not disturbed until exact position for transfer has been determined. Turn the ball over to the **L** at close of second period.
- U** D. Keep **R** informed of remaining playing time. Indicate by inconspicuous signal whether there is ample or scant time for next snap. Advise **R** at the end of the down if time expired while the ball was in play.
- U, H, L** E. Leave the ball alone; **R** will handle it at the end of each period.

SECTION 22.ONE MINUTE INTERMISSIONS

ARTICLE 1. PROCEDURES

- ALL** A. Observe players as they move to the other end of the field.
- R, U** B. Move downfield assuming responsibility of respective teams.
- L** C. Time the one-minute intermission between periods and the one-minute intermission after a safety, try or successful field goal. When 20 seconds remain in the intermission, sound your whistle three times, short but sharp. Move to your position and give a visual signal to the **R** when the intermission expires.
- R** D. Record and announce yard line on which forward point of ball rests and the down and distance loudly and clearly enough for other officials to hear.
- E. Carefully measure distance from nearest marked yard line to forward point of the ball. Distance from the inbounds line may be estimated.
- F. Check with the **H** and **U** on location, down and distance and proceed to corresponding yard line beyond the 50-yard line and spot the ball. Do not resume play until one minute has elapsed.
- U, L** G. Record yard line, down and distance and check **R**, both before and after he changes position of the ball.
- H** H. Determine the yard line which intersects the chain between the rods. Record the down, distance and yard line upon which the ball rests. Grasp the chain at the back edge of the marked yard line, reverse the chain and the assistants holding the rods and move to corresponding line in the other half of the field. Hold the point on the chain at the intersection of that line with the sideline while the assistants tighten the chain. The assistants will then move the chain approximately six feet off the sideline.
- U, H** I. After **R** spots the ball, check for correct spotting and check the down and distance to gain with **R**.
- ALL** J. During the intermission between periods, after other prescribed duties are completed, take positions to observe the teams, but away from the team areas. Upon the **L**'s 20-second remaining notification, verbally notify both teams that 20-seconds remain, and move to positions for the succeeding play.
- U** K. When the succeeding play will be a free kick, upon the **L**'s 20-seconds remaining signal, deliver the ball to the kicker between the inbounds lines, and quickly return to the sideline. Be on the sideline and ready when the intermission expires.
- R** L. Upon the **L**'s visual signal that the intermission has expired, ensure both teams are ready to play, then immediately declare the ball ready for play.

SECTION 23. INTERMISSION BETWEEN HALVES

ARTICLE 1. END OF SECOND PERIOD

- R** A. From the end zone give the start the clock signal when field is clear of officials and players.
- L** B. When time for the half expires, start your stopwatch on **R**'s signal when field is cleared of players and coaches.
- C. Keep other officials informed as to running time. Make sure crew arrives at field to start second half on time, at least 3 minutes before kickoff.
- ALL** D. Secure and retain game ball.

ARTICLE 2. PRIOR TO KICKOFF

- R, U** A. Check with other officials regarding second half choices.
- R, H** B. Five minutes prior to the end of the half-time intermission go to the team that occupies the team area opposite the press box.
- U, L** C. Five minutes prior to the end of the half-time intermission go to the team that occupies the team area on the press box side.
- H, L** D. Bring your team to the team area three minutes before kickoff.
- L, H** E. Check with Head Coach on your sideline and secure the second half option.
- H** F. Make certain your assistants are ready and send them to the receiving team's 20yard line. Remind them to stay behind the restraining line during the kickoff.
- ALL** G. Arrive at your kickoff position no later than one minute prior to kickoff.

SECTION 24. EXTRA PERIODS

ARTICLE 1. END OF REGULATION PLAY

- ALL** A. Direct and escort, if necessary, teams to their respective team areas.
- R** B. Announce or otherwise notify press box that: "Regulation play has ended with a tie score. There will be a brief intermission followed by an extra period of play."
- ALL** C. Gather at the center of the field and review extra period rules and procedures.
- ALL** D. Approximately three minutes following the end of regulation play, break to positions for coin toss.
- L** E. Ensure field clock is turned off or displays 00:00.
- R** F. Ensure 25-second clock is operational.
- R, U** G. Remind head coach of team on your sideline of extra period rules, particularly coin toss and option procedures, and time-outs.

ARTICLE 2. COIN TOSS

- All** A. Approximately four minutes following the end of regulation play, conduct coin toss. Assume same duties as for coin toss prior to start of game (see Section 5), except no introductions.
- R** B. Remind captains that the winner of the toss may not defer choice. Conduct toss, obtain choices from captains, and move captains with their backs to their respective goal lines. Place hand on shoulder of captain (nearest press box) of team winning toss. Stand adjacent to team (to press box side) that will be on offense first and give signal 8 (first down). Simultaneously, announce choices if equipped with field microphone.
- ALL** C. Immediately move to scrimmage positions and begin play without delay.

ARTICLE 3. ADDITIONAL EXTRA PERIOD

- ALL** A. When an additional extra period is required, immediately conduct the option selections with the captains. **R** and **U** move directly to the center of the field and call for captain(s) from both teams. Obtain option from captain of team that had second choice in previous extra period, then option from opposing captain. (Note: Beginning with third extra period, **R** remind captains that only a touchdown can score points on a Try.) **R** indicate choices to press box as noted above. **H, L** perform duties as for coin toss.
- H, L** B. Remind head coach for team on your sideline about time-outs. Also, Beginning with third extra period, remind them that only a touchdown can score points on a Try.

SECTION 25. POST-GAME DUTIES

ARTICLE 1. PROCEDURES

- ALL**
- A. Note total elapsed time from initial kickoff to final whistle including all intermissions.
 - B. Join other officials and leave together. Neither seek nor avoid coaches.
 - C. Complete any required game reports and mail immediately.
 - D. It shall be permissible for the home school game administrator to contact the **R** regarding rules interpretations. Judgment calls will not be discussed.
 - E. All comments must be cleared through the appropriate authority.

ARTICLE 2. INCIDENT REPORTING

The University Interscholastic League has directed that certain incidents be reported. *ANY EVENT THAT DISRUPTS THE NORMAL FLOW OF THE GAME*, officiated by TASO officials, requires a report. Examples included, but are not limited to:

- Abuse from coaches, players or fans
- Fighting by players, coaches and fans
- Serious Injuries
- Unsafe Playing Conditions
- A half time lasting longer than 28 minutes at a Varsity game
- Coach Ejection – ALL levels of play
- Player Ejection – ALL levels of play
- **ALL Targeting Fouls**
- ALL 15 yard penalties involving the sideline
- ALL 15 yard penalties for unsportsmanlike conduct in sub-varsity play, *especially* middle schools or junior high
- For a Varsity game when no Game Administrator is identified

The game administrator is to be informed of the problem the night of the game, when available. Written reports from each official directly involved in the incident shall be submitted within twenty-four hours and may be filed electronically using the TASO or UIL websites. In addition, the official should notify his/her Chapter leadership of the report.

Reporting of other incidents should be done in accordance with Chapter policies and such policies that TASO may adopt.

ARTICLE 3. FIGHT REPORTING PROCEDURES

- A. The official who calls the foul will inform the player, squad member or coach and his head coach of the disqualification.
- B. Within 24 hours of the contest **R and all officials who called the foul or witnessed the action** must complete the UIL or Private School Incident Report available at www.taso.org.
- C. Players who are disqualified from a game must remain in the team area for the remainder of the game.
- D. Coaches who are disqualified from a game may not be in the Playing Enclosure during the remainder of the game.

SECTION 26. SIX-PLAYER FOOTBALL

ARTICLE 1. GENERAL PRINCIPLES:

The exciting 'wide-open' style of play commonly found in Six Player football, combined with such rule differences as all players being eligible to touch a forward pass necessitates alternate officiating mechanics for those contests. The high percentage of forward passes and long runs requires a 'deep' official, akin to the Back Judge in a crew of five officials. To that end, the traditional Umpire's position transforms into that of a Back Judge (**B**), and the following alternate mechanics for certain aspects of the game are recommended for Six Player football.

ARTICLE 2: SCRIMMAGE PLAYS – POSITIONING AND COVERAGE

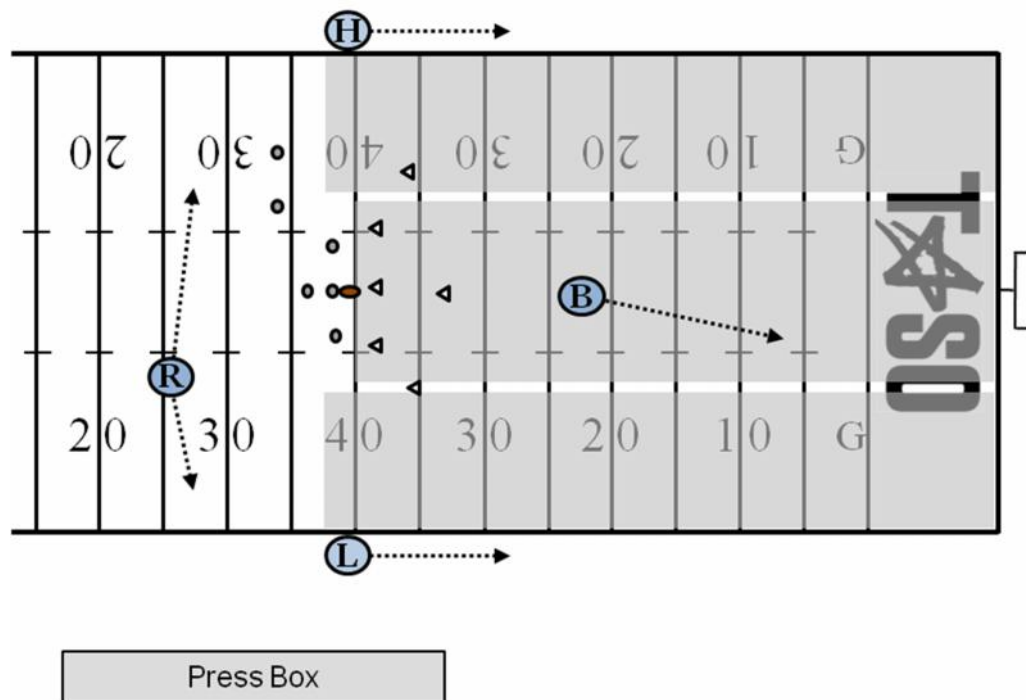

R takes action and runner behind neutral zone, sideline to sideline. **B** 10-20 yards deep (behind all defensive players). **H** and **L** are positioned astride neutral zone, outside sideline.

- R** A. Same pre-snap position; responsible for all action behind neutral zone. Move quickly laterally to cover runner, sideline to sideline. Primary responsibility for legal exchange. Sole responsibility for Passer beyond neutral zone.
- B** B. Pre-snap position 10 to 20 yards beyond neutral zone; adjust to be behind defensive backs, approximately centered on the offensive formation. Other duties same. At snap read play. If running play, cover action of blockers in front of runner. If pass play develops, retreat to stay deeper than all players, cover action in middle zone; shift attention to intended receiver when pass is released.
- L** C. Same pre-snap positioning and duties. At snap, move downfield 10-12 yards and read play. If running play develops, take forward progress as usual. If pass play

develops. Cover action in your zone. Shift attention to intended receiver when pass is released. Secondary responsibility for legal 'exchange.'

- H D. Same pre-snap positioning and duties. At snap, move downfield 10 to 12 yards while reading play. If running play develops, take forward progress as usual. If pass play develops, bracket deep action between you and B. Cover action in your zone. Shift attention to intended receiver when pass is released.

ARTICLE 3: FREE KICK

Because it is so prevalent for 6-Player football teams to utilize the short or "pooch" kick for most or all free kicks, it is recommended that the officials plan on using the short field mechanics for all free kicks. However, if one or both teams demonstrate that they can and will use a deep kick, the R should switch the crew to a deep kick formation.

SHORT KICK MECHANICS:

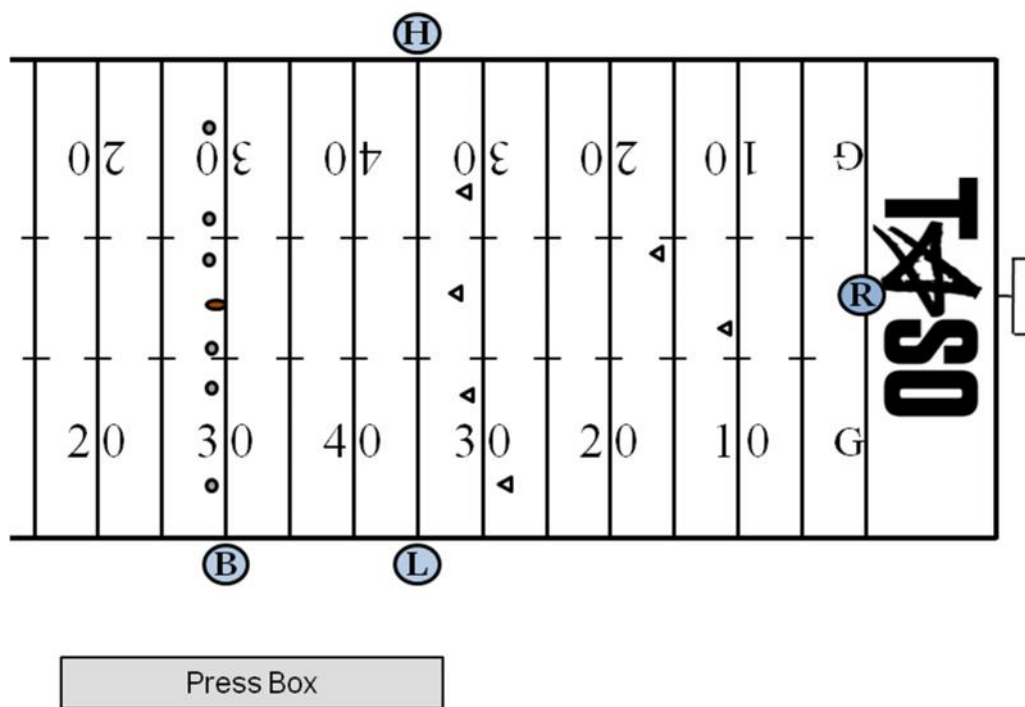

- R A. Take position on the goal line at approximately mid-field. Assure all other officials are in position and ready. Mark ball ready for play and be ready to move quickly to either sideline to rule on free kick out of bounds between the goal lines or behind the goal line. You have sole responsibility for a deep kick at any point on the goal line, including both pylons.
- B B. Hand the ball to the kicker and admonish him to not kick the ball until the ready whistle has sounded. Then move to the kicking team's restraining line on the press box side of the field, or to the wide side of the field if the kicker places the ball on either hash mark. Rule on kicking team off-sides and action against the kicker before he has regained balance. Remain on the sideline after the kick and be ready to cover a run back all the way to the goal line.

- H, L** C. Assume position on the opposite sides of the receiving team's restraining line; **H** opposite the press box, **L** on the press box side. Rule on receiving team off-sides and kicking team players illegally blocking before they are eligible to touch the ball. Cover short kick toward your sideline. Rule on on-sides kick traveling the required 15 yards or touching by the kicking team before being touched by a member of the receiving team. Cover pooch kicks toward your sideline. Responsible for the ball carrier on your side of the field or action around the ball carrier on the opposite side of the field. Cover the ball carrier down your sideline all the way to the goal line.

DEEP KICK MECHANICS:

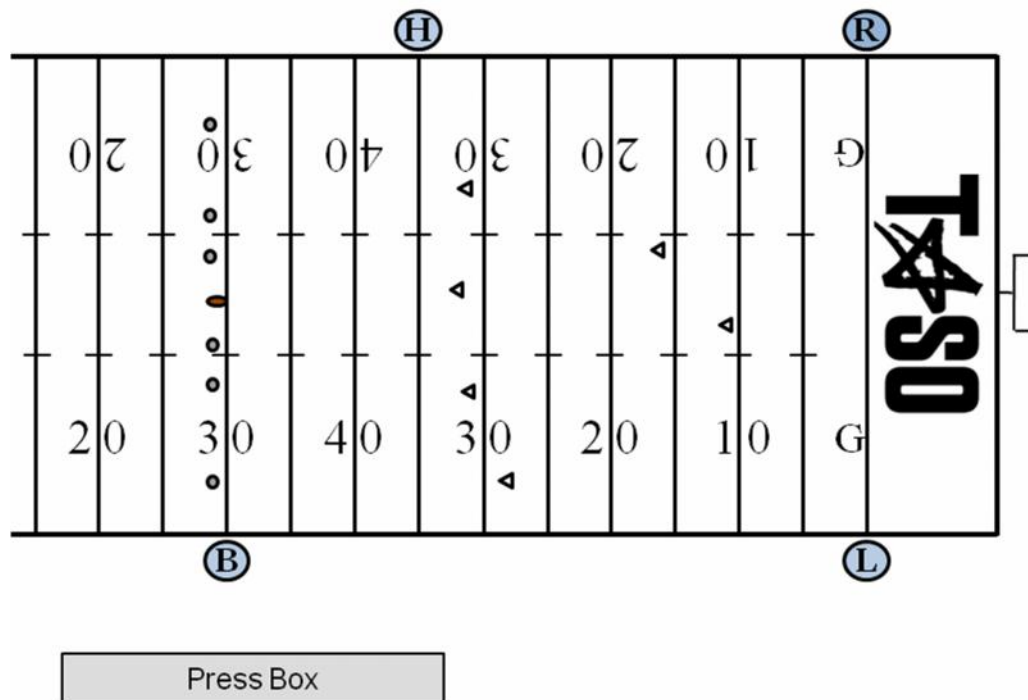

- R** D. Take position on the goal line at the pylon opposite the press box. Assure all other officials are in position and ready. Mark ball ready for play and be ready to move quickly up field to rule on a free kick out of bounds between the goal lines or hold position on the pylon to rule on free kick out of bounds behind the goal line. Responsible for the ball carrier if kicked to your side of the field or action in front of the ball carrier if kicked to the opposite side of the field.
- L** E. Assume position on the goal line at the pylon on the press box side. If agreed upon during the pre-game meeting, you may move 5-10 yards up field for your starting position, but be ready to immediately return to the goal line to rule on free kick out of bounds between the goal lines or behind the goal line. Move quickly up field to cover a pooch kick to your side of the field. Responsible for the ball carrier if kicked to your side of the field or action in front of the ball carrier if kicked to the opposite side of the field.

- B** F. Hand the ball to the kicker and admonish him to not kick the ball until the ready whistle has sounded. Then move to the kicking team's restraining line on the press box side of the field. Rule on kicking team off-sides and action against the kicker before he has regained balance. Remain on the sidelines after the kick and be ready to cover a run back all the way to the goal line.

- H** G. Assume position on the receiving team's restraining line opposite the press box. Rule on receiving team off-sides and kicking team players illegally blocking before they are eligible to touch the ball. Cover short kick toward your sideline. You have sole responsibility for the receiving team's restraining line. Do not vacate your position until the ball has crossed the receiving team's restraining line or it has been touched or acted upon by players on either team before reaching the receiving team's restraining line. Rule on on-sides kick traveling the required 15 yards or touching by the kicking team before being touched by a member of the receiving team. Cover pooch kicks toward your sideline and assist the **L** on ruling for pooch kick to opposite side of the field. Responsible for the ball carrier on your side of the field or action around the ball carrier on the opposite side of the field. Cover the ball carrier down your sideline all the way to the goal line.

ARTICLE 4: SCRIMMAGE KICK

PUNT MECHANICS:

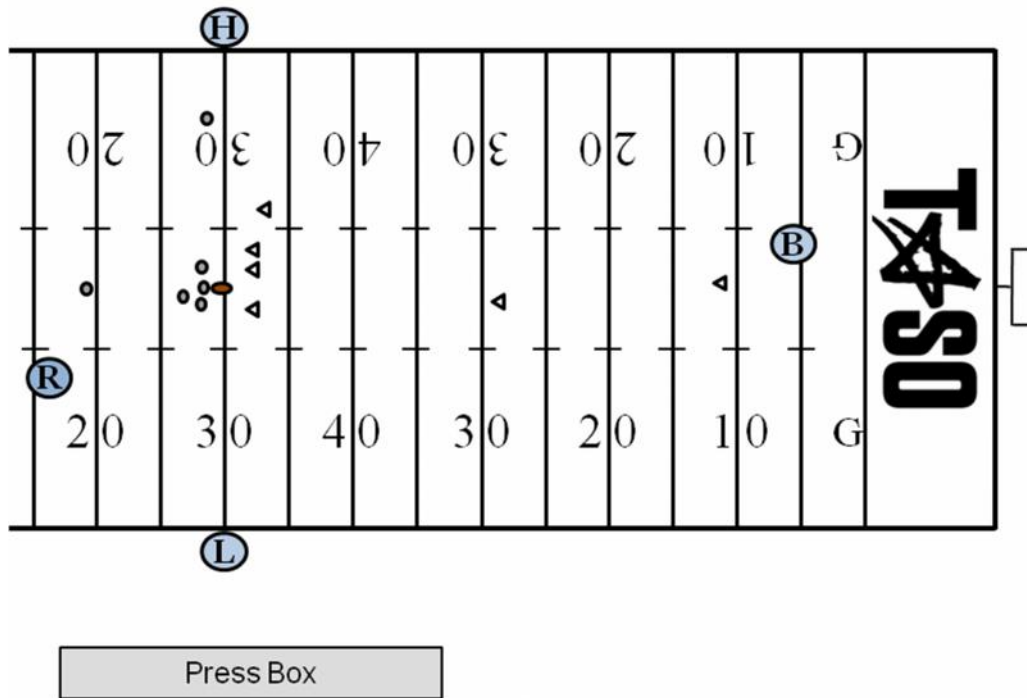

Note: Any time the team in possession of the ball is in a formation that qualifies as a scrimmage kick formation, the deep snapper is afforded protection for one second after the snap.

- R** A. Assume position deeper than the kicker and slightly favor the **L** side of the field. Be ready to rule on running into/roughing the kicker. Watch for touching of the ball by incoming blockers and be aware of who touches the ball and then as subsequent contact with the kicker. Vocalize that the ball is away after the kick to warn off the rushers (preventive officiating). Watch for illegal blocks as the player move downfield in punt coverage. Be ready to cover the ball carrier to the goal line if the kick is run back.
- B** B. Assume position outside and behind the deep receivers. Position yourself on either side so that you may have the best view of the catch. Adjust to play area and assume responsibility for coverage into either sideline. If necessary to retreat, move backward at a 45 degree angle. Watch for fair catch signal and be ready to rule on legality of signal. Responsible for the ball carrier after the catch until turned over to the wing official or **R** on the return. Watch for muff or touching by receiving team. Rule on touchback if the kick crosses the goal line untouched by Team B.
- L** C. Responsible for action down the line of scrimmage prior to the snap – Off sides, false start, illegal snap, minimum of three offensive players on the line of scrimmage at the snap, etc. Remain in position on the line of scrimmage on the press box side until it is apparent that the ball will be kicked. Be ready to assist the **R** on muffs, fumbles, or blocked kick ruling. Move quickly downfield to assist the **B** on fair catch (including signals given by other member of the receiving team other than the deep receiver), muff, fumble or first touching. Responsible for the ball carrier on your sideline all the way to the goal line. Responsible for blocks behind the ball carrier on the opposite side of the field.
- H** D. Responsible for action down the line of scrimmage prior to the snap – Off sides, false start, illegal snap, minimum of three offensive players on the line of scrimmage at the snap, etc. Remain in position on the line of scrimmage opposite the press box until the kick has traveled beyond the neutral zone. Be ready to assist the **R** on muff's, fumbles or blocked kick rulings. After the kick has crossed the neutral zone, move quickly downfield to cover the kick on your side of the field. Responsible for the ball carrier on your sideline all the way to the goal line. Responsible for blocks behind the ball carrier on the opposite side of the field.

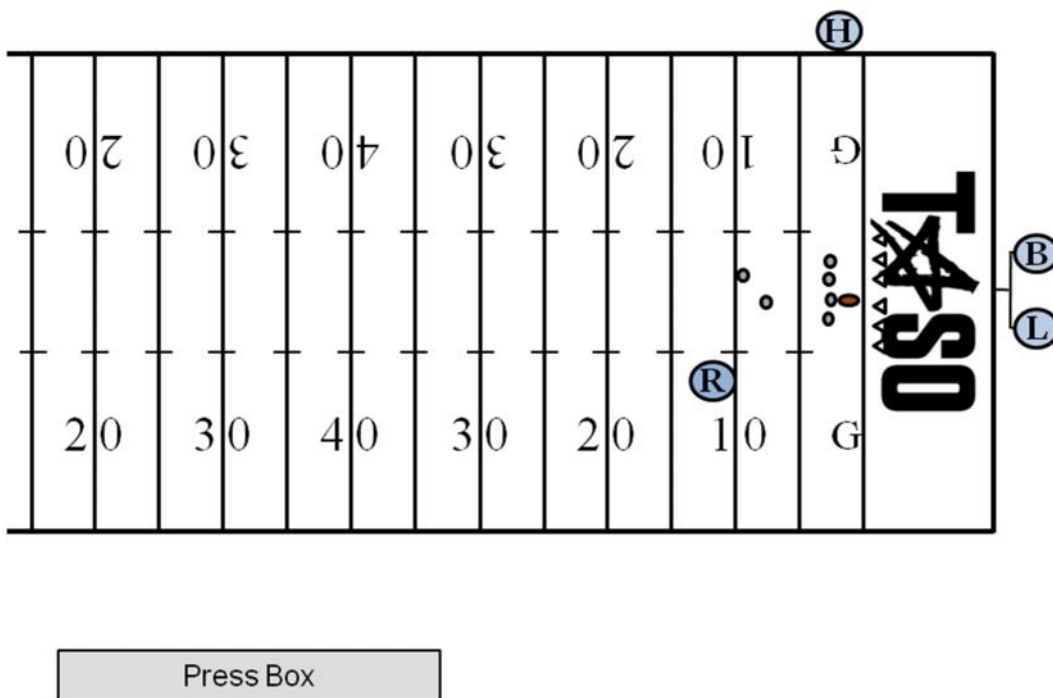
FIELD GOAL OR TRY:

NOTE: On a field goal attempt a blocked or unsuccessful kick that remains a live ball may be acted upon legally by players of both teams. On the try the ball becomes dead whenever it is obvious that the kick is unsuccessful. Although the defense may not score on the try, and the ball becomes dead on an unsuccessful attempt, officials should not blow their whistle until the ball becomes dead by rule. That is; the kick either crosses the crossbar, crosses the end line outside the uprights, crosses the neutral zone and falls to the ground on the field or end zone, or possession of the ball is gained by the defense. Holding the whistle until the ball is clearly dead prevents the possibility of confusion of the timing of a live-ball versus dead-ball foul that may occur during the try.

- R** A. On a try or field goal, **R**'s position is a yard or so to the rear and several yards to the side of the potential kicker, on the press box side, facing the kicker/holder where **R** can see the ball when spotted for the kick. Covers as usual if a run or pass. Assist in sideline coverage if run develops to **L**'s vacated side. Signal score after being positive that requirements are met. Rule on roughing or running into the kicker and/or holder.
- B, L** B. Take position aligned with and behind the uprights; **L** to the press box side and **B** opposite the press box side. Initial position is approximately 3 yards behind the upright, but be prepared to move to a position directly underneath the upright to rule on a kick that passes in close proximity to the top of the upright. When the field goal or try attempt passes directly over or outside an upright, the official nearer the ball may give a sweeping motion with both arms away from the upright. When ruling on whether or not the kick is successful, both move up to the end line and give the appropriate signal. (Successful= S5; Unsuccessful= S10)
- B** C. Responsible for your upright goal post and assist on ruling if ball hits cross bar on kick. If run develops, move to goal line to assist in ruling. If a field goal attempt is

short and ball remains alive, officiate as a scrimmage kick.

- H** D. Responsible for legality of snap, entire line of scrimmage and ensuring one second delay observed by the defense before contacting the snapper. Quickly move to goal line if run develops.
- E. If the kick is short or partially blocked, know if it crossed the neutral zone.
- L** F. Responsible for your upright goal post and the crossbar. If run develops to your vacated side, quickly move along end line to back pylon to rule on the sideline. Next move is toward goal line to assist. If run situations develop to your side, you have primary sideline responsibility with **R**'s assistance. Sound whistle when ball becomes dead on attempted try or field goals.

ARTICLE 5: SPOTTING BALL

- R, B** A. After dead-ball action has ceased, if you are nearest to dead-ball spot or you can secure ball more expediently, move to dead-ball spot and secure ball (or replacement ball from flank official) and spot on flank official's progress spot.
- ALL** B. Take necessary action to keep consistent pace of spotting ball and getting ball ready for play.

ARTICLE 6: SIX PLAYER FOOTBALL RULES

UIL EXCEPTION FOR SIX-PLAYER FOOTBALL:

General: Texas Six-Man Football Rules are the same as NCAA Football Rules Except for the following variations. (Note: NCAA Rule References to the 2015 Rule Book are indicated in parenthesis).

NCAA RULE SIX-MAN RULE VARIATION

- (1-1 & 2) 1. Each team has six players. Number of players changed to **NO MORE THAN SIX** players each in UIL Six Man Games. In UIL Six Man Games, a team needs at least six players to start the game and can play with five or four, but less than four available players should result in suspension of the contest. Unless necessary to use the eleven-man field, the six-man field is 80 yards by 40 yards, with the 40 yard line being the center of the field. The two inbound lines (hash marks) are 40 feet from the sidelines. There will also be marks that are measured 13 feet from the sidelines. Goal posts are 25 feet apart and the crossbar is 9 feet above the ground. **NOTE: UIL (Texas) Six Man Football Rules Variations are listed in the current UIL Football Manual.**
- (1-1-3) 2. When one team is 45 or more points ahead at the end of the first half or if a team achieves a 45 point lead during the second half, the game is ended immediately.
- (3-2) 3. Length of quarters is 10 minutes; between quarters, 2 minutes. Between halves, 15 minutes.

- (3-5-3) 4. Team A may not break the huddle with more than 6 players nor keep more than 6 players in the huddle or in a formation for more than three seconds. Officials shall stop the action whether or not the ball has been snapped. PENALTY: Dead ball foul. 5 yards from previous spot (S22).
Team B is allowed to briefly retain more than 6 players on the field to anticipate the offensive formation, but it may not have more than 6 players in its formation if the snap is imminent. Whether the snap is imminent or has just occurred, the officials shall stop the action. PENALTY: Dead ball foul. 5 yards from previous spot (S22).
- (4-1-3) 5. During a try after touchdown the ball becomes dead when Team B gains possession or it is obvious that a kick is unsuccessful.
- (5-1-2) 6. Offense must advance 15 yards instead of 10 yards in four downs.
- (6-1/6-1-7) 7. Unless relocated by penalty, the kicking team's restraining line on a kickoff is the 30 yard line on a six-man field and the 20 yard line for a free kick after safety. The receiving team's free kick restraining line is 15 yards from the point of kickoff. There is no requirement to have a minimum number of players on either side of the kicker. If the result of a Free Kick is a touchback for Team B, and the placement of the ball is not relocated by penalty, the ball will next be put into play from Team B's 20 yard line.
- (6-1) 8. The ball must travel 15 yards on a kickoff (or place kick/punt after a safety) or be touched by the receiving team before members of the kicking team are eligible to touch it.
- (6-2-1) 9. A free kick out of bound between the goal lines untouched inbounds by a player of Team B is a foul (A.R. 3-IV). PENALTY—Live-ball foul. Five yards from the previous spot; or five yards from the spot where the subsequent dead ball belongs to Team B; or the receiving team may put the ball in play 20 yards beyond Team A's restraining line at the inbounds spot (S19).
- (7-1-4) 10. Unless the ball is kicked or forward passed, it may not be advanced beyond the neutral zone until AFTER AN EXCHANGE has been made between the receiver of the snap and another player. EXCEPTION: Any player of Team A may advance a loose football after it has been touched by a Team B player. Forced touching of a ball by Team B is disregarded. PENALTY: 5 yards plus loss of down (illegal procedure) from previous spot (S19 & S9). An exchange is completed when possession of the football is gained by a receiver of the snap, given up voluntarily or involuntarily by the receiver of the snap, and possession is regained by another player of Team A.
- (7-1-4) 11. If the snap is muffed and a Team A player catches or recovers the ball beyond the neutral zone, he may not advance it. ENFORCEMENT: Loss of down from previous spot (S9). PENALTY: 5 yards from the previous spot for illegal procedure is assessed if the Team A player advances or attempts to advance the ball (S19 & S9). If a Team A player catches or recovers the muffed snap behind the neutral zone, he may legally advance it only after a legal exchange.
- (7-1-4) 12. No more than 3 Team A players shall be in the backfield at the snap.
- (7-1-6) 13. The ball may be handed in any direction to any player during a scrimmage down behind the neutral zone. A linesman may receive a forward hand-off at any time and is

not required to be 2 yards behind his line of scrimmage and does not have to face his goal prior to receiving the hand-off. EXCEPTION: The ball may not be handed forward to the snapper through his legs. PENALTY: 5 yards from previous spot and loss of down (S19 & S9).

- (7-3) 14. The ball is dead when a passer catches his own forward pass (untouched by B), and it is ruled as an incomplete forward pass.
- (7-3) 15. All players are eligible to catch a forward pass, except that a pass is ruled incomplete when caught by the passer (see preceding rule). If a forward pass is thrown to the snapper, it must travel at least one yard in flight.
- (7-3-2-h) 16. The last sentence of the exception does not apply to UIL 6-Man Football Games. Therefore, a player other than the receiver of the snap who is or has been outside of the tackle box may legally throw the ball so that it crosses or lands beyond the neutral zone or neutral zone extended.
- (8-1) 17. Field goals count 4 points; successful try, 2 points if successful through place or drop kick and 1 point if successful by pass or run. The defense may not score on a try.
- (9-1-14) 18. When a team is in an offensive or scrimmage kick formation, and no player is in position to take a hand to hand snap, a defensive player may not initiate contact with the snapper until one second has elapsed after the snap.

~ APPROVED RULINGS ~

Section 1: Exchanges

- I. First down and 15 from A's 35. A10 pitches to A28 who muffs the ball. A10 picks it up and runs to B's 35. RULING: Illegal advance by A. Penalize 5 yards plus loss of down.
- II. First down and 15 from A's 25. A10 pitches the ball backward. It strikes B72 and is loose on the ground. A10 picks up the ball and runs to the 40 (midfield). RULING: A's ball first down and 15 on the 40. NOTE: by definition, when the ball strikes B72, it has been touched by Team B player.
- III. A15 hands the ball to A40. While still behind the line A40 hands the ball forward to A15 who advances beyond the line for a ten yard gain. RULING: Legal advance by A15.
- IV. A12 receives the snap and possesses the ball. He hands the ball forward to A60, the snapper by handing it back between his legs. A60 advances 5 yards. RULING: Illegal Advance by Team A. PENALTY: 5 yards and loss of down.
- V. A15 receives the snap and hands off to A38. A38 fumbles the ball and it is picked up by A45 (1) behind the line of scrimmage; (2) beyond the line of scrimmage. A45 advances for 10 yard gain. RULING: A legal exchange has been made. A45 may advance the football in (1) & (2) as long as it is not fourth down.

- VI. A12 receives the snap and pitches the ball to A45 who muffs the pitch and is attempting to catch the ball (bobbling it) as he crosses the neutral zone. A45 then catches the ball and advances for a five yard gain. RULING: Illegal advance by A. PENALTY: 5 yards and loss of down.
- VII. A's ball first down and 15 at A's 20 yard line. A8 muffs the snap. It is picked up by A25 behind the neutral zone and advanced to A's 30. RULING: Illegal advance by A. Penalize 5 yards plus loss of down from the line of scrimmage. No legal exchange has been made since A25 was the first to possess the ball after the snap and then advanced the ball beyond the neutral zone without an exchange.
- VIII. A's ball second and 5 at A's 24. A13 receives the snap and fumbles the hand-off to A30. A30 recovers the fumble and hands the ball back to A13 who advances it to A's 32. RULING: A's ball first down and 15 at the 32 yard line.
- IX. A10 muffs the snap from A50. The ball rolls a few yards beyond the neutral zone where A6 (1) picks up the ball and advances; or (2) falls on the ball for the recovery. RULING: (1) Illegal, 5 yards previous spot plus loss of down. Penalty marker is dropped, play continues. (2) Legal recovery, no foul, the ball is returned to the line of scrimmage, loss of down. A legal exchange has not been made prior to advancement of the ball beyond the line of scrimmage.
- X. A25 receives the snap and immediately throws a backward pass to A40 who muffs the pitch. A40 scoops up the ball from the ground and advances beyond the neutral zone. RULING: Legal, a backward pass has been thrown and a legal exchange has been completed.
- XI. A's ball first and 15 from B's 22. A10 receives the snap and hands the ball to A20. The ball is fumbled by A20 and A70 recovers at B's 19. RULING: Legal advance by A, unless it is 4th down.
- XII. A's ball 4th and 1 at B's 30. A10 receives the snap and fumbles the hand-off to A22. A22 picks up the football and advances to B's 25. RULING: Ball is dead when A22 picks up the football. No advance is allowed. NCAA Rule 4-1-3-j applies and prohibits advance. A10 may pick up the loose ball and complete an exchange for a legal advance.
- XIII. Third down and 4 at the A30. A10 receives the snap and possesses the ball. Rushing defender B55 is legally blocked by A61 and falls to the ground in front of A10. A10 reaches out with the ball and touches it to the shoulder pad of B55, and then runs the ball to the B38 where he is tackled. RULING: Illegal advance for no legal exchange in the backfield. Forced touching is disregarded by rule. Penalize 5 yards from the previous spot and loss of down. A's ball 4th and 9 at the A25.

Section 2: Passing

- I. A15 attempts a forward pass which is batted in the air by B73. A15 catches the ball and advances it 10 yards. RULING: Legal. Ball was touched by B.

- II. First and 15 yards to go for A at their 15 yard line. A9 hands the ball forward to A30. A30 runs to the left and passes the ball to A60 while still behind the line of scrimmage. RULING: Legal pass by A30.
- III. A15 receives the snap and retreats 10 yards to his own 20 yard line. Due to a heavy pass rush he immediately passes the ball to A50, his snapper, who is standing on the 21 yard line. RULING: Legal pass since the ball traveled at least one yard when passed to the snapper.
- IV. A8 attempts a pass at the line of scrimmage. B75 tips the ball and it is caught by A55, the snapper, at the line of scrimmage. The ball has only traveled 1/2 yard in the air. RULING: The tipping by B makes A55's reception a legal catch and A55 may advance the ball.
- V. A's ball 4th and 4 at B's 22. A10 throws a pass which strikes A73 and bounces into the air. A10 catches the ball and advances 5 yards where A10 fumbles the ball. RULING: Incomplete forward pass. B's ball first and 15 at their 22. (Six-Man Rule variation No's 12 & 13)

Section 3: Other Plays

- I. Team A lines up at the line of scrimmage with three men on the scrimmage line next to each other in a three point stance. A80 located on the right side of the snapper raises up and shifts out 7 yards. RULING: Since A80 is at the end of the line this is a legal shift.
- II. Team A lines up with four men on the line of scrimmage next to each other in a three point stance. A62 who is covered up by A80 (1) raises up from his 3 point stance before the snap; or (2) receives a forward hand-off and advances 4 yards; or (3) catches a forward pass 10 yards beyond the line of scrimmage. RULING: (1) False start. (2) & (3) Legal.
- III. Team A lines up with 4 men on the scrimmage line next to each other. A88, on the end line, leaves his position and goes in motion before the snap. At the snap, he is (1) moving toward his opponent's goal line; (2) moving away from his opponent's goal line and 2 yards behind the line of scrimmage. RULING: (1) Illegal motion since A88 cannot be moving toward his opponent's goal. (2) Illegal motion by A88. He must set for one second after leaving line. A lineman may not be in motion at the snap.
- IV. Team A's kickoff from their 30 yard line rolls out of bounds untouched by Team B at B's 38. RULING: B may snap the ball at their own 38, 30, Team A's 37, or accept the penalty against A for illegal procedure and have Team A re-kick.
- V. B is leading 60-19. They return the second half kickoff 65 yards for a touchdown. RULING: Game ends.

- VI. B is leading 50-10 in the second half. B intercept's A's pass and returns it 16 yards for a touchdown. B44 clips on the run back. RULING: If A declines the penalty the game ends and there will be no try for point.
- VII. A's ball 4th down and 5 from their 20 yard line. A14 punts the ball which is blocked and goes straight up in the air. A45 catches the punt behind the line of scrimmage and advances to A's 40 yard line. RULING: Legal advance by A, first down and 15 yards to go.
- VIII. Team A attempts a try from any legal point and:
 - (1) Team B recovers a legal fumble, picks it up and advances the ball into Team A's end zone; or
 - (2) Team B intercepts a fumble or forward pass and advances the ball into Team A's end zone; or
 - (3) Team B blocks the try, gains legal possession and advances the ball into Team A's end zone; or
 - (4) Team B blocks the try and A12 picks up the ball and advances into Team B's end zone.

RULING: No score, ball is dead when it is obvious that the kick is unsuccessful.

SIX-MAN FOOTBALL GOALPOST DIMENSIONS

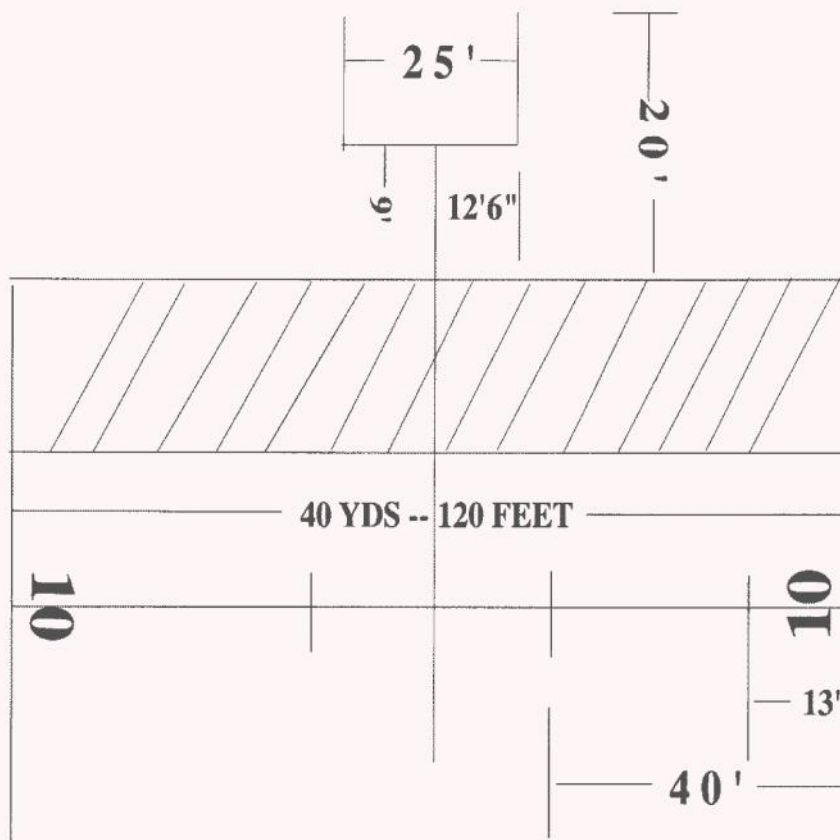

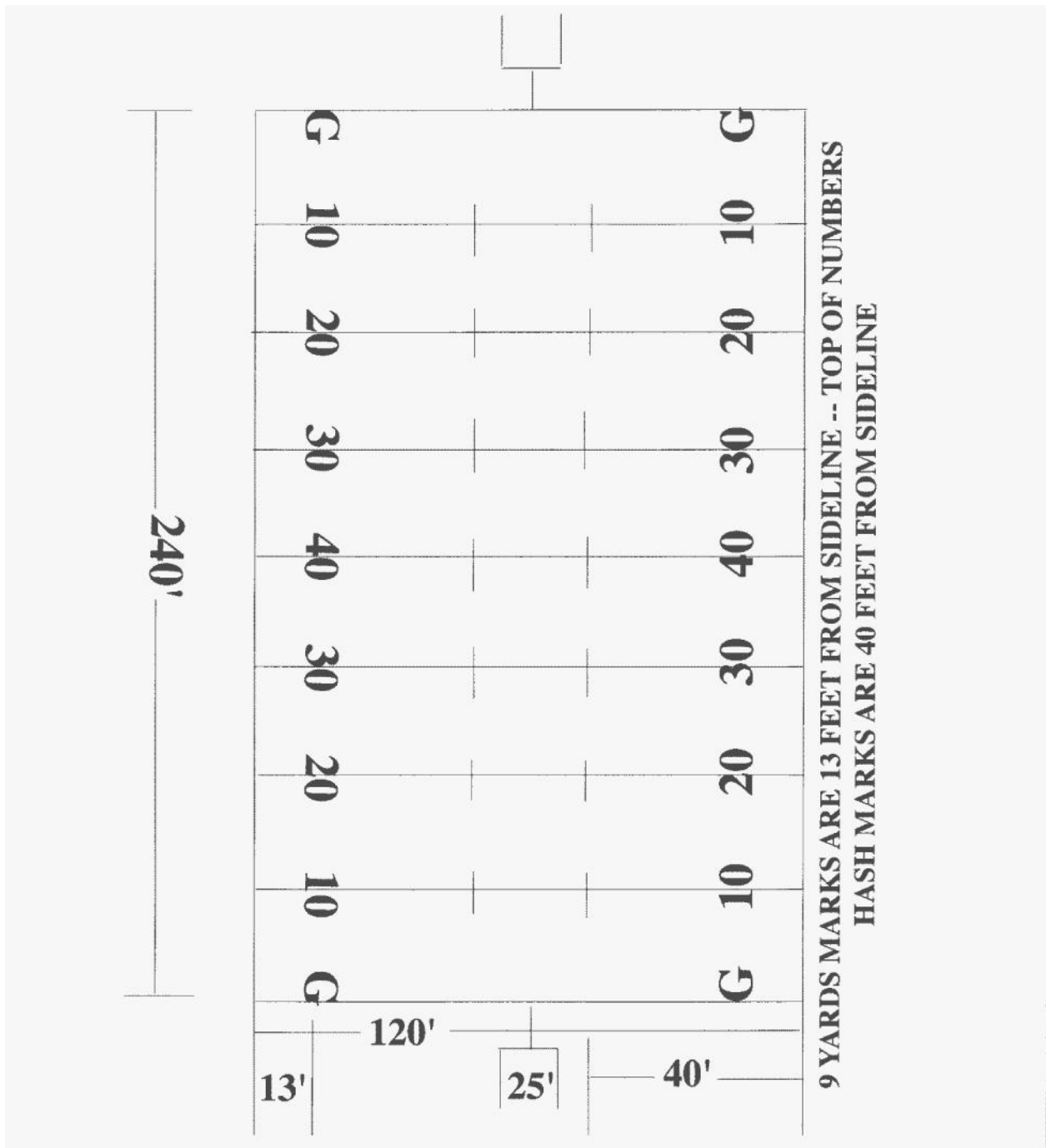

SECTION 27. TASO OFFICIATING PHILOSOPHIES

Guidelines and Tips for Texas High School Football

Officiating Philosophies, Points of Emphasis, Guidelines, and Tips are to be used in connection with the 2019-2020 NCAA Football Rules, Texas High School Football Rule Exceptions, and TASO Football Officiating Mechanics. They are not intended to be in conflict with any rule, exception, or mechanic. An Officiating Philosophy is not part of the rules. Points of Emphasis are special actions we want to take before, during, and after the game. Guidelines are to help simplify some rule and game situations. Tips are saying and advise that has been passed down and shared among officials.

Officiating Philosophies do not take the place of common sense and good judgment by officials. They are not intended to replace the continued study of the Rule Book and Mechanics Manual. They are an aid to officials in an attempt to provide consistency in officiating certain types of plays, so as much as possible, eliminate the differences from crew to crew, game to game, week to week, and chapter to chapter.

Abbreviations used:

CHBChop Block	KO Kickoff
CLPClipping	LTG Line to Gain
COPChange of Possession	LOS ... Line of Scrimmage
DHDefensive Holding	NZ Neutral Zone
DOG ...Delay of Game	OFK ... Offside Free Kick
DOFDefense Offside	OH Offensive Holding
DPIDefensive Pass Interference	OB Out of Bounds
DQDisqualification	OPI Offensive Pass Interference
EZEnd Zone	PF Personal Foul
FOPField of Play	POA ... Point of Attack
FSTFalse Start	RPS ... Roughing the Passer
GLGoal Line	RTH ... Roughing the Holder
IBBillegal Block in the Back above the Waist	RTK ... Roughing the Kicker
IDPIllegally Downfield on Pass	TB Touchback
IFPIllegal Forward Pass	TD Touchdown
ILFIllegal Formation	T. O. ... Time Out
ILSIllegal Substitution	UNR ... Unnecessary Roughness
ILMIllegal Motion	UNS ... Unsportsmanlike Conduct

Aiding the Runner:

- A foul only if the runner is “picked up” by teammates or if he is “pulled” into end zone by a teammate.
- It is not a foul if “driven” into the end zone or forward by his teammates.
- Most of the time, this happens near the GL or short yardage situations, but illegal and legal actions apply anywhere on the field.

Announcements:

- Practice your microphone skills. The fans love this part of the game.
- Practice even when you do not have a microphone.
- Be sure to turn the microphone off after your announcement.

Backward Pass:

- When in question, the pass is forward, not backward.
- When the QB’s hand starts forward with the ball, rule the pass forward even if he is contacted and the ball goes backward.

Bean Bags:

- Fumbles: Officials shall drop the bean bag only when they see the ball fumbled, not when they see the ball loose.
- Punts: Officials shall drop the bean at the spot the kick ends or the spot of illegal touching.
- Be accurate. You are marking a potential enforcement spot.
- Do not drop your bean bag after an interception, except when inside the 5 yard line.

Blocking:

- If there is a potential OH, but the action occurs clearly away from the POA and has no (or could have no) effect on the play, OH should not be called.
- It is not blocking below the waist if the initial contact is above the waist, and the blocker then slides down and makes contact below the waist.
- To be a foul for IBB, the initial contact of the block must be from behind and above the waist. When in question, the block is below the waist. First contact is the key, not the position of the blockers helmet.
- It is not a foul for IBB if the initial contact is from the side.
- If the blocker is in a CHASE MODE, ALL of the contact must be on the side.
- You should not call OH on a double team block unless there is a takedown or the defender breaks the double team and is pulled back.
- A block from behind below the waist is a CLP. Clipping is legal if within the Tackle Box and above the knee if the ball has not left the Tackle Box.
- If a defender has beaten the blocker be alert for OH. If he is beat, the blocker, is going to cheat. Watch the feet.

Ball Persons:

- Have good communication and a good pre-game meeting.
- Keep them in the game. Keep them off of the field.
- Tell them you will let them know when you want a new ball. Don't let them make that decision.

Catch:

- If the process of the catch includes going to the ground, the receiver must maintain possession of the ball when he contacts the ground to be awarded a catch. The ground can cause an incompleteness. This is the same in the FOP and the EZ.
- These requirements are the same for interceptions and fumble recoveries.
- There is a difference in the ball moving within the receivers control and moving from a loss of control.
- If the receiver is contacted simultaneously with or immediately after he controls the ball with one foot down and loses possession, rule the pass incomplete.
- A play that would be ruled a catch/fumble in the field of play would be ruled a catch/TD in the end zone.

Catchable Forward Pass:

- For a pass to be ruled uncatchable, it must be BLATANTLY uncatchable. If there is any question the pass shall be ruled catchable.
- Give the uncatchable signal only if you would have thrown a flag for OPI or DPI if the pass had been catchable.

Chain Crew:

- Remind the chain crew they are part of the officiating crew and are expected to conduct themselves in a professional manner. No cheering or comments. Instruct them to move only on the HL's signal.
- If TASO Officials are on the chain, include them as much as you can.

Chop Block:

- High: If a blocker is engaged with the defender above the waist, a teammate may not block the engaged player below the waist. A high/high block is legal.
- Low: if a blocker is engaged with the defender below the waist, a teammate may not block the engaged player above the waist. A low/low block is legal.
- It is a foul for a CHB even if the high blocker has just disengaged with the defender when the low blocker contacts the defender.
- There must be contact by both the high and the low blocker to be a CHB foul.

Clocks:

- Game Clock: The Referee may make any clock adjustments necessary.
- Game Clock: If an official sees time remaining on the Game Clock, when a T. O. is called, put time back on the game clock even if reads 0:00 when the officials get the game stopped for the T. O.

- Play Clock: Once the play clock reads: 00 the official will look for the ball. If the ball is still on the ground and not in the process of being snapped it is a foul for DOG. If the ball is being snapped, no foul for DOG.
- Play Clock: The Referee may reset the play clock to: 25 if necessary.
- If the clock operators do not come to the dressing room prior to the game report it to the Athletic Director. If they are TASO Officials, report it to the Chapter.
- If time is being kept on the field turn the scoreboard clock off.
- Know the signals used if the play clocks are not working. Turn both off if one is not working.
- Be sure the crew has a watch to time if necessary.
- If the game clock has less than 0:02 seconds remaining when ball is snapped, this will be the last play of the game unless the period is extended by rule.

Coach to Coach Communication System:

- This is not covered by the rules, and the officials are not involved.
- If one team's communication goes down, the officials may notify the other Coach, however, there is no rule of Equity and no obligation for the other team to put theirs down unless there is a district rule

Coin Toss:

- Make this a memorable experience for the captains and their families.
- Make the captain call the toss before you toss the coin. Repeat his choice back to him.
- Let the coin hit the ground. Give good signals to the Press Box.

Consistency:

- Coaches want consistency in what is and is not a foul so they know what to coach.
- Do not call a foul in the 4th Q that you passed on earlier in the game.
- Do not pass on a call in the 4th Q that you called earlier in the game.
- Do not call a foul near the goal line that you passed on near midfield.
- Do not pass on a call near the goal line that you called near midfield.
- Be consistent in marking the ball ready for play throughout the game.

End of Game:

- If an offensive team goes into a victory formation, officials should use common sense officiating and make every attempt to not call fouls that have no bearing on the outcome of the game.
- Personal Fouls and Player Safety Fouls should always be called regardless of time and score.
- If the Referee stops play for any reason, the game is suspended and not over.
- The official's jurisdiction ends when the game is over.

Equipment:

- Both teams must certify in writing before the game that all of their players are equipped according to rule and have been instructed the proper use of their equipment.

- If equipment becomes illegal through play, the team will not be charged a T.O. however, the player must leave the game until the illegal equipment is corrected.

Face Mask:

- Touching the Face Mask or a grab and release is not a foul. There must be a pull or twist and turn to be a foul.
- The grab, pull, twist, and turn of any helmet opening is a foul.
- Face Mask restrictions apply to the offense and defense.

False Start:

- A flinch is a flinch and a FST. This applies to both Lineman and Backs.
- If an ineligible offensive player is going from a 2 point stance to a 3 point stance when the ball is snapped, this is a FST.
- If an eligible offensive player is going from a 2 point stance to a 3 point stance when the ball is snapped is ILM.
- QB head bobs or jerks are FST. QB hard counts are not fouls.
- Ineligible offensive lineman who have their hand on or near the ground can turn and look at the QB to hear the signals if they are slow and do not lift their hand.
- Pointing at the defender as part of the offensive signals is not a FST.
- If the center flinches, head bobs, or moves the ball, this is a FST. Especially if this is only done on 4th downs or short yardage situations.
- Be alert for the defense calling the offensive snap count that causes a FST.
- A defender making a non-football move that causes the offense to FST is a foul for DOG.

Field:

- If both teams are on the field, an official must be on the field to keep the teams separated. Jurisdiction is 30 minutes prior to KO, but use good judgment if there is a potential for problems.
- The Referee will request a change to anything in, on, or around the field he believes is unsafe.

Flags

- There is no such thing as a "late flag". Sometimes, it is necessary to wait until all of the action has stopped to make a ruling.
- Go slow. See the play, read the play, then, make the call.
- There is no such thing as "that's not your call ". All officials are responsible for their primary area and secondarily responsible for ruling on action legal or illegal anywhere on the field.
- Do not throw flags at players. Throw your flag up in the air unless it is a spot foul.

Fighting:

- If player actions are deemed to be "fighting", the player must be DQ.
- When in question, such actions will be deemed pushing and not fighting.
- If players come off of the bench on to the field, they are deemed to be fighting by rule.
- In the pre-game, be sure the Coach understands this is an automatic DQ by rule.

Formations Defense:

- If the center adjusts or moves the ball forward after the defense has established position on the LOS, the defense should not be penalized for DOF as they have been put into this position by actions of the offense.
- A defender is considered on the LOS if any part of his body is inside the rearmost part of a down lineman's body.

Formations Offensive:

- Officials will work to keep offensive lineman legal and call ILF only when obvious or when warnings to the Player or Coach are ignored.
- Do not wait until the 4th quarter to start enforcing this rule.
- A wide receiver or slot back is covering up a tight end if there is no stagger. When in question, it is not a foul.
- Do not be technical in determining if a wide receiver or slot back is on or off the LOS. When in question, it is not a foul.

Free Kicks:

- The kicking team restraining line for regular deep or pooch kicks will be a SOFT plane, and the officials will not be technical on calling OFK.
- The kicking teams restraining line for an onside kick will be a HARD plane, and the officials will call OFK if the kickers (other than the kicker) break the plane of the kicking teams restraining line before the ball is kicked.
- The receiving team restraining line is a plane, and a kickoff has gone 10 yards when the ball has broken the plane and remains beyond the plane of the receiving teams restraining line. (The wind could blow it back)
- If the kickoff results in a TB or Fair Catch do not call a foul for an illegal wedge formation or OH.

Fumbles:

- When in question, the runner fumbled the ball and was not down.
- When in question, the ball is passed and not fumbled during an attempted forward pass.
- The ground cannot cause a fumble. If the runner with the ball in his possession, contacts the ground with something other than his hand or foot and the ball comes out simultaneous with the contact the ball becomes dead. You cannot fumble a dead ball.

Fouls:

- See the play, read the play, make the call. Go slow in calling fouls.
- If you think it's a foul it is not. If you know it's a foul it is.
- If you don't see the entire play don't throw a flag.

Game Balls:

- There is no such thing as a kicking ball. All balls submitted for approval prior to the game must be rotated in and out of the game as necessary.
- When the U places the ball on the ground he has deemed the ball acceptable for play.
- Do not let a team request a new ball late in the 25 count to keep from getting a DOG
- Good crew ball mechanics is a very important part of the game.
- The crew must have an air pressure test gauge, an air pump, and a marker, to test, inflate and mark the game balls in case the officials' dressing room does not have these items.

Game Control:

- Control of the game is not lost in one play. It happens a play at a time until control is lost.
- Preventive officiating will keep the game pace and eliminate potential fouls.
- “Let them play” does not mean let them foul.
- Fouls that create an unfair advantage or player safety should be called anytime during the game regardless of time and score.

Goal Line:

- When in question it is not a Touchdown.
- When considering whether or not a receiver has taken the ball out of the end zone on a kick, interception, or recovery, it is the position of the ball rather than the position of the player or his feet that will determine if the entire ball is out of the end zone.
- The entire ball must be in the FOP or it is a touchback or safety when coming out.
- The entire Goal Line is in the end zone.
- When in question a foul occurred in the FOB and not in the end zone
- Consider an interception or catching a kick inside the 1 yard line to be in the end zone.

Hide Out & Trick Plays:

- Formations and actions during the execution of a trick or unusual plays must be completely legal.
- Any play that uses a substitution to deceive as part of the play is illegal.
- If a play can only be run in front of a team’s bench area it is probably illegal.
- Officials must be aware of all substitutions, especially ones that could create an ILS foul.
- A player may fake a spike and throw a pass.
- A player may not fake “taking a knee”. This makes the ball dead.

Holding Defense:

- It is not DH if the defender is restricting the offensive player in a personal attempt to get to the ball or the runner.
- A grab of the receiver’s jersey that restricts and takes away his feet is DH.
- Do not call DH if the action occurs clearly away from the POA and has no effect on the play.
- If a defender holds and restricts an offensive player and a teammate shoots the gap this is DH
- If the defender holds and restricts an offensive player and no one shoots the gap this is not DH unless this action prevents the offensive player from getting to their blocking assignment. (next level)

Holding Offensive:

- To have OH there must be a clear and visible material restriction: a pull, a yank, or a jerk.
- Make the defense “show you something” Like trying to get away.
- Categories of OH: Tackle, Pullover, Grab & Restrict, Hook & Restrict, Take Down, Jerk & Restrict.

Horse Collar Tackle:

- It is not a foul for a Horse Collar Tackle inside the tackle box.

- To have a Horse Collar Tackle the runner does not have to be tackled. If the immediate action buckles the runners knees but he is strong enough to fight through the action it is still a foul.

Illegal Forward Pass:

- The second forward pass from behind the LOS is IFP.
- If beyond the LOS the spot from where the ball was first touched or hits the ground must be in advance of the spot where the ball was released to be IFP.
- For the QB to be called for IFP the QB's ENTIRE BODY and the BALL must be beyond the LOS when he RELEASES the ball.

Ineligible Downfield:

- For a restricted offensive player to be illegally downfield on a forward pass that crosses the LOS the ENTIRE player's body must have been more than 3 yards past the LOS before pass is RELEASED to have a foul for IDP.
- If the QB is throwing the ball away do not call IDP.

Intentional Grounding:

- The QB can throw the ball anywhere if he is not under pressure. Exception: Cannot spike the ball to stop the clock unless it is immediately after the snap.
- The QB can throw the ball at the feet of an eligible receiver even if he is not looking.
- If the QB is outside the pocket and throws the ball away to avoid a sack and there is a question as to if the ball went beyond the LOS rule that it did.

Kicking a Loose Ball:

- When in question, if a loose ball was kicked, it will be ruled accidental and not a foul.
- Intentionally kicking a loose ball and illegally kicking the ball are not the same.

Leaping:

- Jumping straight up to block a Try or FG is not a foul. Landing on a player is the foul.
- Know who on the defense is in a restricted leaping position.
- It is a foul to leap over a blocker behind the NZ (punt shield) when attempting to block a kick.

Line of Scrimmage:

- Defensive players who jump into the NZ and are moving back will be ruled to be DOF anytime there is a question as to did they get back on side before the snap.
- If the defense is crowding the NZ, any forward movement by the defense puts them into the neutral zone.
- 2 Offensive Players Protected: If a defender moves into the NZ in the gap between 2 offensive linemen causing one of the linemen to react it is a foul for DOF.
- 3 Offensive Players Protected: If a defender moves into the NZ head up on an offensive lineman causing that lineman or an adjacent lineman on either side to react it is a foul for DOF.
- Backs and Split Receivers are not protected.
- The defender must be in the NZ when the offense moves for this to be DOF.
- If the offense moves and the defender was not in the NZ this is a FST.
- Contact by the defense prior to the snap is DOF.
- The defense cannot touch the ball after it has been made ready for play.

- Rule a defender as “unabated” when his charge takes him past the hip of the offensive tackle before the ball is snapped.

Measurements:

- Always allow a reasonable request for a measurement.
- Do not allow a team a measurement to keep from a DOG penalty.
- Do not allow a measurement after a touchback. The ball must touch the appropriate yard line to be a first down.
- Do not allow a measurement after a kickoff OB that was spotted 30 yards from the kickoff spot. The ball must touch the appropriate yard line to be a first down.
- Be sure the Press Box or TV cameras have a clear view of the measurement.
- Rotate the ball with the nose facing the goal line before measuring.
- Don’t move the ball then measure.
- Hold the ball to keep it from moving prior to the measurement.
- Be sure the chain has tape in the middle. Never walk off a 5 yard penalty then measure.

Momentum:

- If a pass is intercepted near the goal line (inside the 1 yard line) and there is a question as to whether possession is gained in the FOP or the EZ, make it a TB.
- If intercepted inside the 5 yard line and the players momentum take him into the EZ where he goes down, give him the ball at the spot of the interception.
- Use the same philosophy in ruling if the catcher of a free or scrimmage kick should be a TB or possession in the FOP.

Out of Bounds:

- If you think a runner stepped OB he did not.
- Throw your hat when an eligible receiver steps OB.

Overtime:

- You must know the Overtime Rules and if the District plays Positive Points.

Pass Interference Defense:

- There must be contact to have DPI and the legal pass must be untouched and catchable by rule.
- There can be no DPI on a pass that does not cross the LOS. There can be DH but not DPI.
- There is no face guarding rule.
- Both offensive and defense have equal rights to the ball.
- No DPI on an eligible receiver who went OB on his own.
- Most DPI fouls will fall into these categories:
 - Not playing the ball
 - Playing through the back of the receiver.
 - Grabbing the receivers arm.
 - Arm Bar to slow receiver down.
 - Cutoff the receiver’s route.
 - Hook & Turn. Must turn before ball gets there. Hand on back or waist is not a foul without the turn
- DPI is not coached.

Pass Interference Offense:

- Blocking downfield on a pass that crosses the LOS.
- Push off creating separation
- Pick plays.
- Must be more than 1 yard beyond the LOS to be a foul.
- Do not call OPI or IDP if an attempted screen pass is overthrown and lands beyond the LOS.
- OPI is coached.

Personal Fouls:

- Spitting on an opponent is a DQ.
- When late hits occur away from the ball near the end of the play, when in question make them dead ball PF not live ball.
- Flagrant PF is a DQ.
- Contact fouls are UNR. Non-contact fouls are UNS.

Pocket:

- Pocket is not an NCAA Rule Book term. The rule book uses the term Tackle Box.
- The pocket (tackle box) goes from tackle to tackle all the way back to the passers end line.
- The pocket (tackle box) goes away when the ball leaves the pocket and does not come back even if the ball comes back into the original pocket area.

Pre-game

- A good pre-game conference is vital to the success of the crew.
- Use the time on the field during warm ups to get some snaps and reps at your position.

Professionalism:

- From the time you arrive at the stadium until you leave, how you dress, act, talk, and treat other people is a reflection on you, your fellow officials, and your Chapter.

Pylon:

- The Goal Line pylon is OB behind the goal line.
- If the ball in player possession touches the Goal Line pylon it is a TD.
- A player who touches the Goal Line or End Line pylon is OB
- A loose ball that touches any pylon is OB.
- The End Line Pylon is OB and not part of the end zone.

Roughing/Running into Holder, Kicker and Passer

- The holder can be roughed. Be careful in calling running into the holder. Remember he can get up and run. If contact is very late it is RTH.
- When in question it is RTK. If the defender hits the kicker's plant leg it is RTK. If he hits his kicking leg it can be either RTK or RNK.
- When in question it is RPS if the defender is attempting to punish.
- RPS can be the result of a legal hit that was late.

Sideline:

- Use common sense in working with the team on your sideline to stay back.
- Let them coach but don't let them interfere with you doing your job.

- Sideline control is a safety issue.
- Good communication with your sideline is an important part of the game.
- Be respectful and reply to questions. Do not reply to comments.
- Conduct sideline conferences with the Coach on the sideline. Not on the field.

Signals:

- The dead ball signal kills the play just like a whistle.
- Good signals by the officials make the game play better.
- Do not signal TD unless you are the covering official. Don't repeat another official's TD signal.

Spots:

- Always mark the forward progress spot with your downfield foot.
- Spot the ball with the same pace throughout the game unless there is an up tempo offense or time is running out. Do not let a hurry up offense take you out of your game. Hustle to get the ball spotted when necessary but you must mechanically do your pre snap responsibilities first even in a hurry up offense.
- The ball should be spotted where it was when it became dead not where it became dead.
- The wrist is part of the hand and the ankle is part of the foot. Rule a player down when something other than his hand or foot touches the ground.
- The back of the hand does not make the runner down.
- HL, LJ practice cross field mechanics.
- Know when you see a double action. Don't give the runner too much progress.
- If the penalty for a foul says it is from the previous spot, go back to where the ball was snapped and then enforce the penalty yardage for the foul.

Targeting:

- When in question, it is a foul for targeting.
- When there is no question there is a foul for targeting, it shall be deemed to be a flagrant foul and the penalty will include disqualification, regardless the number targeting fouls the player has previously committed during the game.

Touchdown:

- If the ball in player possession breaks the plane of the goal line it is a TD and the ball becomes dead. Go slow in ruling TD. Look at the other officials if you need help before you signal.
- Your TD signal kills the play and the ball becomes dead.

Touching the Ball:

- If a player who is passive and not blocking is blocked into the ball he is not deemed to have touched the ball.
- If a player who is active and blocking touches the ball it is touching.
- On a punt when in question the ball was not touched by kickers or receivers.

Trys & Field Goals:

- The 4th down fumble rule applies on try's.
- A kick that hits the cross bar or upright can score a goal, otherwise it becomes a dead ball.

- A pass, free kick, punt, or fumble that hits the goal post is dead.
- Check with the Offense before spotting the ball for a 2 point try. They may want to put it on the right or left hash mark. If it is placed at a hash mark by request of the offense it can only be moved if the offense calls a T. O.

Unsportsmanlike Conduct:

- Allow for brief, spontaneous, emotional reactions at the end of plays.
- Do not allow prolonged actions or taunting actions made toward an opponent.
- Actions such as throat slash, gun references, sexual motions, spiking the ball, or actions that are aimed to draw attention are UNS fouls.
- Kicking or throwing an officials flag is a DQ.
- A player disqualifies himself. We only enforce the rule.

Video:

- Watch and study as much video of yourself and others as possible.
- Watch games on TV from your position.
- Practice your keys when watching TV or video.

Weather:

- Know the weather and lightning rules for stopping and restarting the game.

Whistles:

- On some plays there may not be a whistle.
- Officials are instructed to blow the whistle only when they see the ball dead in player possession.
- It does not matter what type of whistle you use or if you have it in your mouth or not during the play.
- What matters is why and when you blow the whistle.
- There will be no inadvertent whistles if the officials go slow and blow the ball dead only when it becomes dead by rule.

X's & O's

- Learn some football coaching terms.
- This will help when communicating with coaches.

Yard Lines:

- The ball can be spotted on a yard line to begin a new series after a COP. Exception: If the COP occurs after a failure to make the LTG because of an incomplete forward pass or a run that was short of the LTG after a measurement you do not move the ball.
- At all other times the ball will be spotted where it becomes dead.

Zones:

- Know your zones.
- Tackle Box
- Legal Blocking Below the Waist Zone
- Neutral Zone
- Side Zone
- Outside/ Inside numbers.
- Free kick blocking zone

PRE-GAME CONFERENCE

IN OFFICIALS' DRESSING ROOM

ALL Set watches to correct time. Check equipment; whistles markers, game cards, etc. **R** and **U** will provide information from coaches. Review kickoff time, toss time, unusual plays, players are properly equipped. Review where and how line to gain indicator is to be worked, instruction to ball persons, location of testing and marking game balls. Review instructions for clock operators, (Sec 7), and Rules changes. Discuss crew realignment if an official gets injured.

TEAM DRESSING ROOMS: (HOME TEAM FIRST)

R One hour 15 minutes before toss, if possible, otherwise no later than 45 minutes before toss. Give head coaches official time. Obtain name(s) and number(s) of captain(s). Make certain teams are equipped according to rule. Review length of half, 5-minute warning, second half options on field and sideline administration.

U Inspect equipment and bandages of each team. Check with head coach or his designated representative for assurance that his players are equipped in compliance with NCAA rules.

ON THE FIELD:

ALL Inspect field markings, end on your bench.

R Instruct 25-second clock operator(s), if not done prior to arrival on field.

H Check line to gain and instruct assistants; instruct ball persons (w/ **L**).

L Instruct auxiliary box man and ball persons (w/ **L**).

R Arrange for your captains at toss.

U Spot check equipment and arrange for your captains at toss.

L Instruct game clock operator(s) if not done prior to arrival on field.

COIN TOSS:

R, U Escort captains to center of field.

H Stay on sideline with line to gain assistants.

H, L Remain with your teams, holding team's ball pending outcome of toss.

R Introduce captains to each other, conduct toss, signal winner, signal options chosen, option waived until second half.

ALL After toss move quickly to the center of field. Record results of toss. **U** obtain correct game ball and break to kick off positions.

SECOND HALF OPTIONS:

- R, U** Escort captains to mid-field.
- H, L** At proper time, go get and stay with your teams.
- H** Stand by on your 50-yard line. Have assistants ready.
- R** Obtain and signal choices.
- ALL** Arrive at kickoff positions no later than one minute prior to kickoff.

KICKOFF AND OTHER FREE KICKS:

Note: Primary free kick mechanics for 11-player football; alternate for six-player football, to be used when game conditions dictate. Discuss "short kick" mechanics as primary for six-player football.

- ALL** Break to positions from mid-field for opening kickoff of each half.
- U** Instruct kicker and move to A's restraining line at sideline opposite press box; A's nine yard mark restrictions. Ensure correct number of players on either side of kicker. Count kicking team players. Sound whistle immediately if ball falls from tee before kicker makes contact.
- L** Take position at B's pylon on press box side. Count B players.
- R** Take position at B's goal line pylon opposite press box. Count B players. When all are ready, declare ball ready for play and start 25-second count.
- H** Receiving team's restraining line opposite press box, outside and remain outside until ball is kicked, count receivers.
- ALL** Clear restricted area then raise arm to indicate ready. **R** will make ball ready.
- H, L** Restraining line fouls, short kicks, kicking team players out of bounds.
- U** Action on and by kicker.
- ALL** **R** and **L** have end zone. Covering official winds the clock. Illegal touching, untouched kick out of bounds, blocking below waist, fair catch, kick catch interference, forward hand-offs, special adjustments for obvious onside kick (11-player football), free kick after safety same.

RUNNING PLAYS:

- R** Basic position, **R** should, but not mandatory, work on the throwing arm side of the QB, and be 12-14 yards wide from the original position of the ball and 12-14 yards deep. Responsible for 25-second count.
- U** Basic position varies to formation, 5-7 yards deep (7-9 for six-player football) and out of linebackers flow.
- H, L** In side zone extended, be wide, stay on or near the sideline, mark offensive scrimmage line with foot for flankers, off field if necessary.
- L** Responsible for game clock and all interval timing.

- R** Cover runner behind neutral zone, get ball on short out of bounds plays.
- U** Interior linemen, correct numbers, defensive signals. Legal snap, linemen moving, cover inside out and clean up away from ball on runs in side zone. Clip zone, chop blocks.
- H, L** Be wide, use arm/hand signals, action by end/linebackers on your side, legal snap, man in crack back position, chop block, man in motion away from you, encroachment, action in front of runner toward you, runner on your side beyond zone, when run is away from you clean up action on QB after pitch or hand-off. Pitchman when to your side. Encroachment your call, 9-yard mark restrictions.

PASSES:

- ALL** Same basic positions and coverage as on running plays.
- R** Action by, on, around passer, intentional grounding, pass from on or behind line, direction on drop-back, work passing arm side of QB is optional. If QB is sacked, mark dead-ball spot with bean bag. PROTECT PASSER.
- U** Know ineligible, action on or by close in backs, linemen downfield, where first touched. Help on button hook and low short passes.
- H, L** Know ineligible on your side by position and number, blocking by or on eligible receivers, eligible receivers out of bounds (drop hat), quick pass direction, sideline yours. Help on first touching. Momentum exception for Team B.

PUNTS:

- R** Kicking foot side of kicker is optional, 5-6 yards outside and even with kicker's final position. Help to spot out of bounds kick if needed.
- U** Defensive player over center, turn with flow, work center.
- H** Same basic position as run or pass. If Team B fouls, know if post scrimmage fouls apply.
- L** Press box side of field, outside and slightly ahead of deepest receiver or tandem receivers. Bean bag end of kick.
- R** Blocking and action behind line, action by, on or near the kicker.
- H** After snap, hold until ball crosses neutral zone before going downfield.
- H, L** Defensive backs, illegal touch, signals, action in front of ball.
- ALL** Be alert for blocking below waist, short or blocked kick, catch interference and illegal touching.

FIELD GOALS AND TRYS:

- R** Initial position favoring **L** side, responsible for roughing/running into kicker/holder when snapped inside 15; behind holder if snapped on/outside 15.

- L** Behind goal if snapped on/outside 15; have the call all the way. Position on end line at inbounds line if snapped inside 15; take 'over/under.
- U** Favor **L** side, coverage as any kick.
- H** Line play, neutral zone. Responsible for roughing/running into kicker/holder when snapped inside 15.
- ALL** On short or partial block, know if ball crossed neutral zone. Kick that does not score, same as punt, fair catch, blocking, etc. **L** know if and where unsuccessful kick is touched. Review coverage, especially if run or pass develops.

GOAL LINE PLAYS:

- ALL** Coverage same as any scrimmage play except be ready to move. Be alert for score; sound loud whistle when you rule a score. Move in if not sure, help if pile-up, nearest official will dig out ball. **R** will signal if score.

TIME OUTS:

- R** Free.
- U** Cover and hold ball position.
- L** Time all time outs & intermissions, 20-second remaining signal to **R**.
- H, L** Team on your side.

MEASUREMENTS:

- H** Grip chain at spot and bring in.
- L** Mark spot for clip.
- U** Stretch chain only once.
- R** Make ruling.
- L** Have replacement ball for spotting at inbounds line if not a first down.

CALLING AND REPORTING FOULS:

- ALL** Fouls by jersey color or offense/defense or A/B, number/position of offender. **Report Who fouled, What was the foul, Where did the foul occur and When did it occur.** **R** will state foul. **R** will give preliminary signal. Flank officials notify coaches on all fouls number/ position. One official hold spot of foul. Check **R**'s options and **U**'s enforcement.

END OF PERIOD:

- R** Signal end of period, record down, distance and yard line.
- U** Check and accompany **R**. Notify **R** if between downs.
- H** Record yard line of clip, move line to gain indicator.
- U** Check **H** and assist **L** in observing teams.
- L** Move downfield observing teams, go to approximate position for ball. Time all intermissions.
- ALL** End of first half, record elapsed time and any fouls to carry over to next kickoff.
- R** End of first half, from end zone, signal clock operator to start the field clock when field is clear of players and coaches.
- ALL** Leave together at half and at conclusion of game.

GENERAL PROCEDURES:

- ALL** Responsible for legality of the 9-yard marks. Offensive players must comply with 9-yard mark restriction. Forward progress without fanfare, hold until sure **U** has spot. Keep written record of toss, timeouts, major fouls, warnings on sideline administration. Players out of bounds on kicks and passes. Status and position of ball on fouls. Fumbles; report jersey color on possession. Discuss dig-out procedure. Stop clock signal. Discuss winding signals by **H** and **L**. Know down and distance of each play. Assure **R** makes ball ready. Be sure one-second stop is observed. Discuss encroachment and sideline coverage. Correct numbering.
- R, U** Count offense
- U** Help defensive signal calling.
- H, L** Count players from your bench.
- U** Keep **R** posted near end of quarter when clock is to his back.
- ALL** Hustle!

APPROVED SIGNALS



Official Football Signals

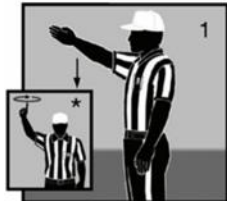

1
Ready for play
*Untimed down

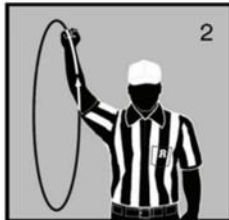

2
Start the clock



3
Stop the clock



4
TV/radio timeout



5
Touchdown
Field Goal



6
Safety



7
Dead-ball foul/
touchback
(move side to side)



8
First down



9
Loss of down

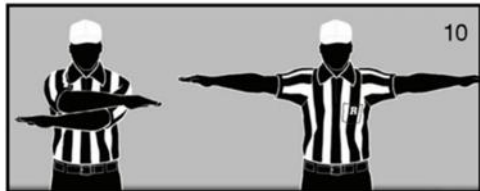

10
Incomplete pass/unsuccessful try or
field goal/penalty declined/
coin toss option deferred



11
Legal touching



12
Inadvertent whistle



13
Disregard flag



14
End of period

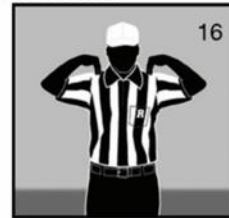

16
Illegal touching



17
Uncatchable pass

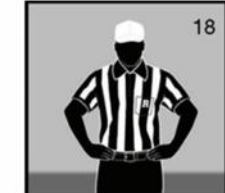

18
Offside B/Offside A
or B on kickoff



19
False start/
Encroachment A
Illegal formation



20
Illegal motion (1 hand)
Illegal shift (2 hands)



21
Delay of game



22
Substitution
infraction



Official Football Signals



23
Equipment violation



24
Targeting

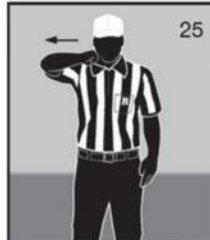

25
Horse-collar

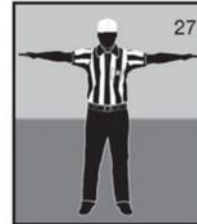

27
Unsportsmanlike conduct

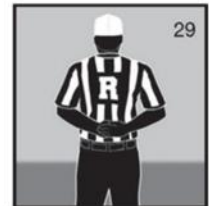

29
Sideline interference
Note: Face press box when giving signal.



30
Running into or roughing the kicker or holder

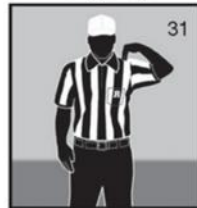

31
Illegal batting/kicking
(for illegal kicking, follow with a point toward foot)



32
Illegal fair catch



33
Pass interference
Kick-catching interference



34
Roughing the passer



35
Illegal pass
Illegal forward handing
Note: Face press box when giving signal.



36
Intentional grounding



37
Ineligible downfield on pass



38
Personal foul



39
Clipping

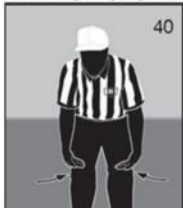

40
Block below the waist
Illegal block



41
Chop block



42
Holding
Obstructing
Illegal use of the hands or arms



43
Illegal block in the back



44
Helping the runner
Interlocked blocking



45
Grasping of face mask or helmet opening



46
Tripping



47
Disqualification